

**ALUMINCO**<sup>®</sup>  
ALUMINIUM BUILDING SYSTEMS



CLASSIC  
LINE 

*Classic railings with modern aesthetics  
Garde-corps Classic sont toujours La Classe*



40  
40 YEARS OF  
EXCELLENCE

**ALUMINCO**<sup>®</sup>  
ALUMINIUM BUILDING SYSTEMS



**40 years offering innovative and sustainable solutions for architectural aluminium systems. And we keep on going!**

Since 1982, targeting the international community of architects, designers, engineers, construction perfectionists and fabricators, ALUMINCO offers a complete range of architectural aluminium solutions that are innovative, energy efficient and sustainable, embodying top quality, high functionality and contemporary design standards.

In Aluminco we implement Quality, Environmental, Occupational Health and Safety, and Energy Management Systems certified according to international standards ISO 9001, ISO 14001, ISO 45001 and ISO 50001 respectively, as well as Factory Production Control System certified according to EN 15088, EN 1090 and Qualicoat Seaside Class. All our product series are approved by certified by internationally recognized institutes for their outstanding characteristics and performance.

**Depuis 40 ans Aluminco propose des solutions innovantes et durables pour les systèmes architecturaux en aluminium. Et on continue !**

Depuis 1982, ciblant la communauté internationale des architectes, designers, ingénieurs, professionnels de la construction et fabricants, ALUMINCO propose une gamme complète de solutions architecturales en aluminium innovantes, écoénergétiques et durables toute en incarnant une qualité supérieure, une fonctionnalité élevée et des normes de conception contemporaines.

Chez Aluminco, nous mettons en œuvre des systèmes pour la gestion de la qualité, de l'environnement, de la santé et de la sécurité au travail. Notre usine est de ce fait certifié selon les normes internationales ISO 9001, ISO 14001, ISO 45001 et ISO 50001. Également le contrôle de la production est certifié selon les normes EN 15088, EN 1090, les certifications Qualicoat, Qualimarine, et Qualanod font également partie de notre gestion de qualité. Afin de répondre à toutes les normes de sécurité différentes en vigueur, nos produits sont certifiés par des instituts internationalement reconnus.

WE ARE  
A PART OF  
TOMORROW



# EMBRACING CLASSIC TRENDS!

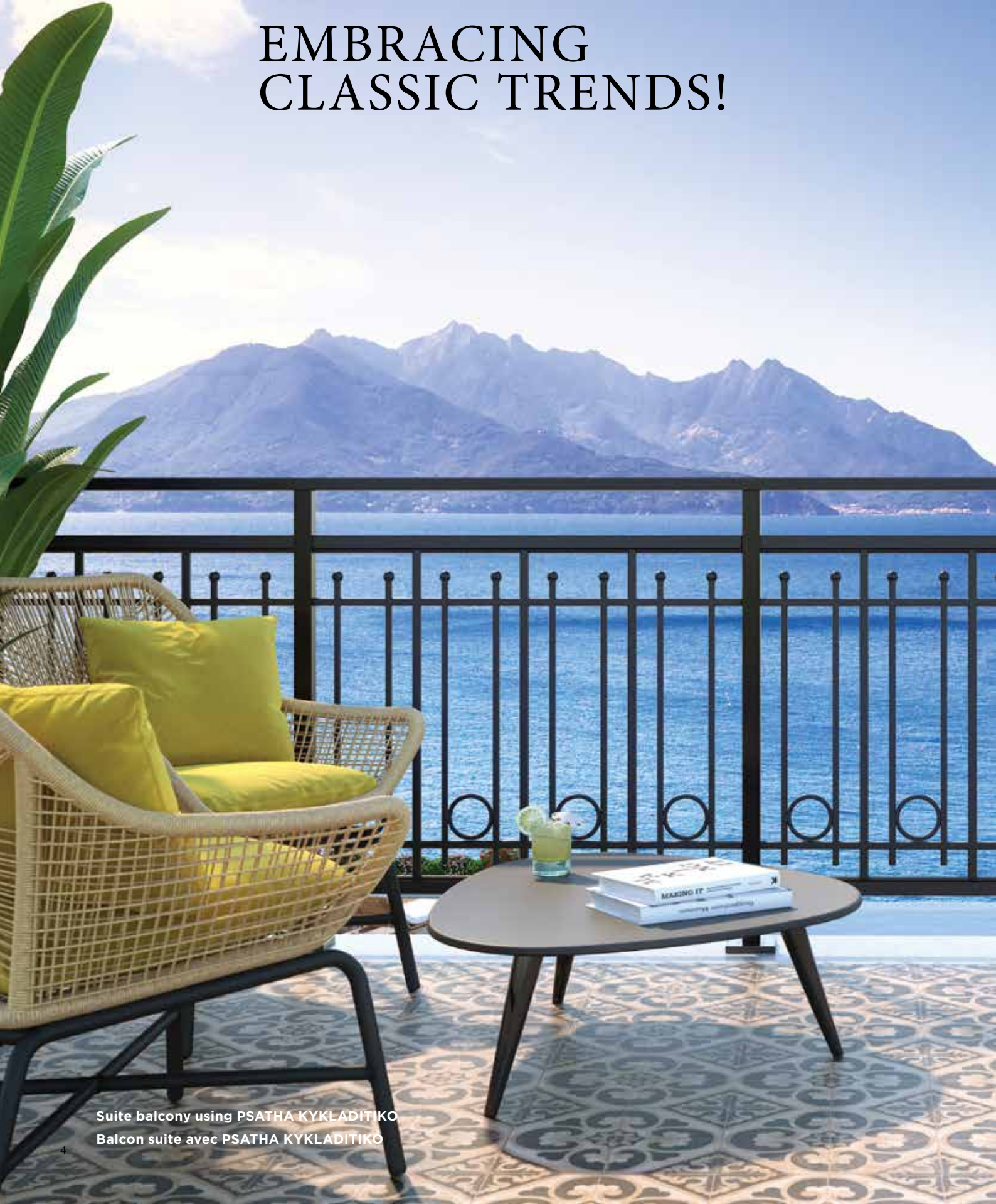

Suite balcony using PSATHA KYKLADITIKO  
Balcon suite avec PSATHA KYKLADITIKO

The panoramic view over Ionian Sea and the green hillsides that tumble down to blue-green seas is splendid, but it is not the only memorable feature that this balcony has to offer.

Selecting Classic Railings, have made this home a State-of-the-art!

La vue panoramique qui donne à la mer Ionienne ne serait pas aussi surprenante et appréciée sans le “regarde” au travers de ces garde-corps?

Grace aux garde-corps Classic Line votre balcon ou terrasse se transforme a l' espace le plus favorisé.



MAKE A REAL  
STATEMENT!



Our classic collection is built on the know-how of more than 35 years. From commercial buildings to diverse residential styles, each solution is a work of art.

Discover our complete line of classic solutions, the CLS, the ALFLEX and the PSATHA collections.

Durability, quality, and style are assured. Unlimited options that build lasting experiences for outdoor living spaces.

Notre collection classique est basée sur un savoir-faire de plus de 35 ans. Dès bâtiments commerciaux jusqu'aux divers styles résidentiels, chaque solution est un véritable œuvre d'art.

Découvrez notre gamme complète de solutions classiques, les collections CLS, ALFLEX et PSATHA.

La durabilité, la qualité et l'élégance sont assurés. Des options illimitées créant une expérience durable aux espaces de vie extérieurs.



**Residential villa using CLS-H1**  
**Villa luxueuse résidentielle utilisant CLS-H1**

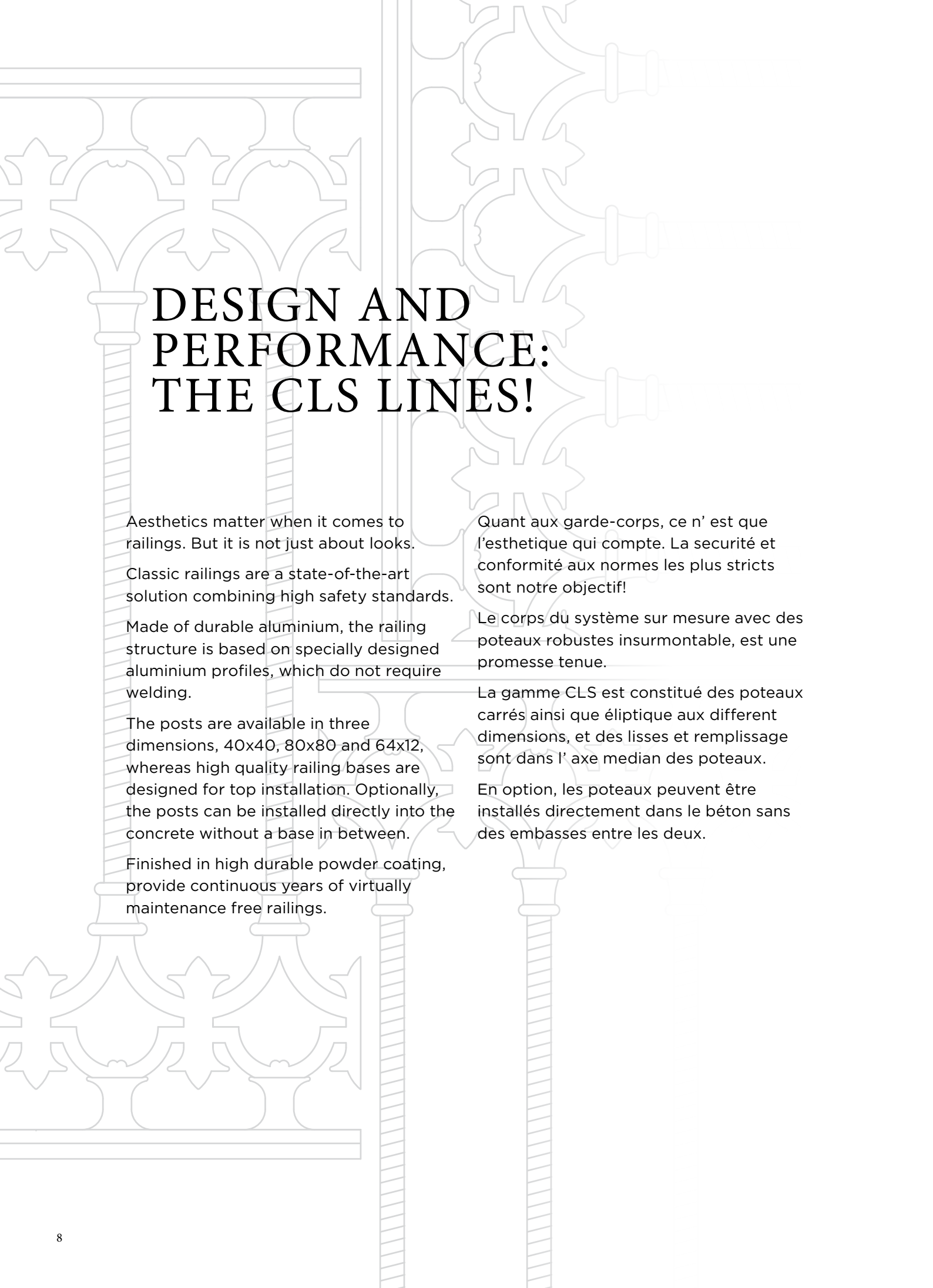

# DESIGN AND PERFORMANCE: THE CLS LINES!

Aesthetics matter when it comes to railings. But it is not just about looks.

Classic railings are a state-of-the-art solution combining high safety standards.

Made of durable aluminium, the railing structure is based on specially designed aluminium profiles, which do not require welding.

The posts are available in three dimensions, 40x40, 80x80 and 64x12, whereas high quality railing bases are designed for top installation. Optionally, the posts can be installed directly into the concrete without a base in between.

Finished in high durable powder coating, provide continuous years of virtually maintenance free railings.

Quant aux garde-corps, ce n' est que l'esthétique qui compte. La sécurité et conformité aux normes les plus stricts sont notre objectif!

Le corps du système sur mesure avec des poteaux robustes insurmontable, est une promesse tenue.

La gamme CLS est constitué des poteaux carrés ainsi que élliptique aux différent dimensions, et des lisses et remplissage sont dans l'axe median des poteaux.

En option, les poteaux peuvent être installés directement dans le béton sans des embasses entre les deux.



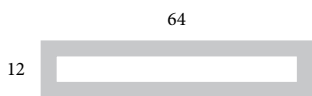
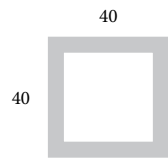
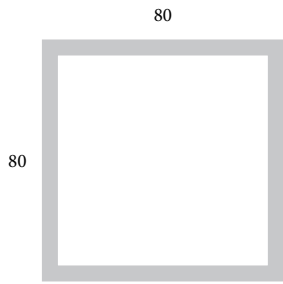



# *The CLS edition*

Classic meets  
contemporary style!

The CLS collection epitomizes styling trends of the day: elegant clean lines, vertical to each other, well balanced, square shape to the body and sleek lines.

18 different linear models, available in many configurations, meet any requirement from private homes to commercial buildings and heavy traffic areas.

La collection CLS répond aux tendances stylistiques contemporaines: des lignes épurées et élégantes, verticales les unes par rapport aux autres, bien équilibrées, de forme carrée sur le corps avec une belle surface.

18 modèles différents, s'étendant de haut en bas ou presque, répondent aux tous besoins et à toutes les exigences en terme de conception et de durabilité, garantissant une solution de garde-corps fiable à des différents domaines d'application.



Securing public spaces using CLS-A2  
Clôture aux espaces publics avec CLS-A2



34

35

24

**Block of flats using CLS-E1**  
**Bloc d'appartements utilisant CLS-E1**





CLS-C2



CLS-D1



CLS-F2



CLS-G1

# *The* CLS WAVE

Super privacy on the covered area!

Using the framing of CLS railings, the Wave infills provide a maximum level of privacy and safety.

Utilisant le corps des garde-corps CLS, les remplissages Wave offrent un haut niveau d'intimité et de sécurité, principalement posés à l'extérieur comme clôture ou balustrade.







Beach house using CLS WAVE 1  
Maison au bord de la mer avec CLS WAVE 1



CLS A1

CLS B1

CLS C1



CLS D1

CLS E1

CLS F1



CLS G1

CLS H1

CLS WAVE 1



CLS A2

CLS B2

CLS C2



CLS D2

CLS E2

CLS F2



CLS G2

CLS H2

CLS WAVE 2



*The*  
**ALFLEX**  
*edition*

Excitingly unique  
pieces of heritage!

Ocean view balcony using ALFLEX EROTAS  
Balcon vue mer avec ALFLEX EROTAS



The ALFLEX collection was conceived to cater for staircase enclosures apart from balconies and terraces.

As “flexible” is the key word, the series offers 17 different designs and all necessary connectors, to ensure any type of installation possible.

Ideal for new as well as remodelled homes.

La collection ALFLEX a été conçue pour la réalisation des rampes d’escalier ainsi que des balcons et terraces.

Ayant la flexibilité comme objectif, nous avons créé 17 modèles de barreaudage décoratif, qui font le remplissage à l’aide de plusieurs connexions et raccords.

Ideal pour des nouvelles maisons ainsi que pour la rénovation.





Modern mansion using ALFLEX AGIOKLIMA  
Manoir moderne utilisant ALFLEX AGIOKLIMA



65-41  
AKANTHOS



85-34  
KAMARA





85-31  
LOUVRE



85-30  
AGIOKLIMA



AGIOKLIMA

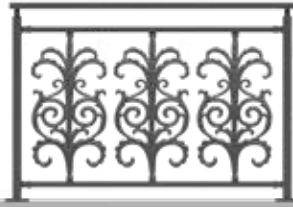

AKANTHOS



ASTERI A

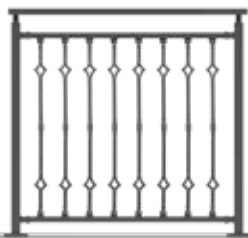

ASTERI B

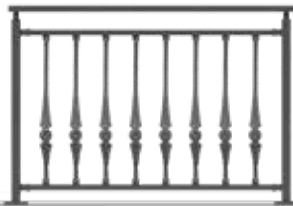

VENETIAN

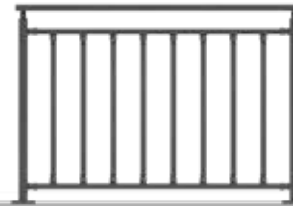

LINEAR 104

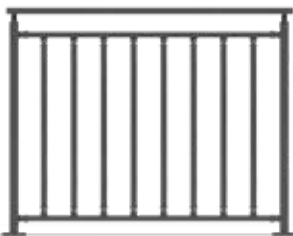

LINEAR 828



DILOS



EROTAS



SUN

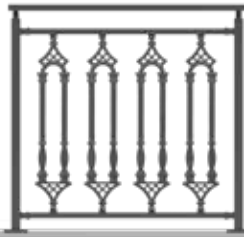

KAMARA

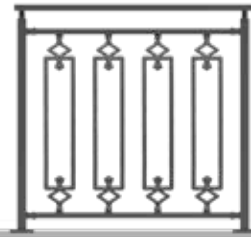

KOLONATO

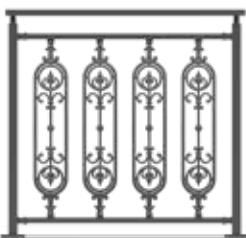

KORONA



LOUVRE

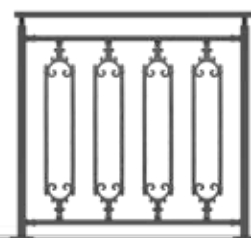

MAKRIYIANNI



MINOAN A



MINOAN B

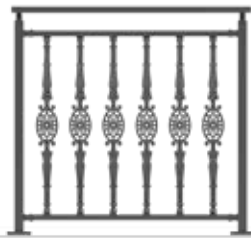

ROKA



SAITA

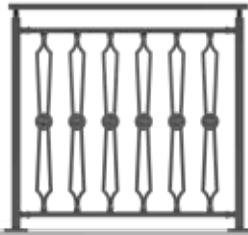

ARROW



TUSCANY



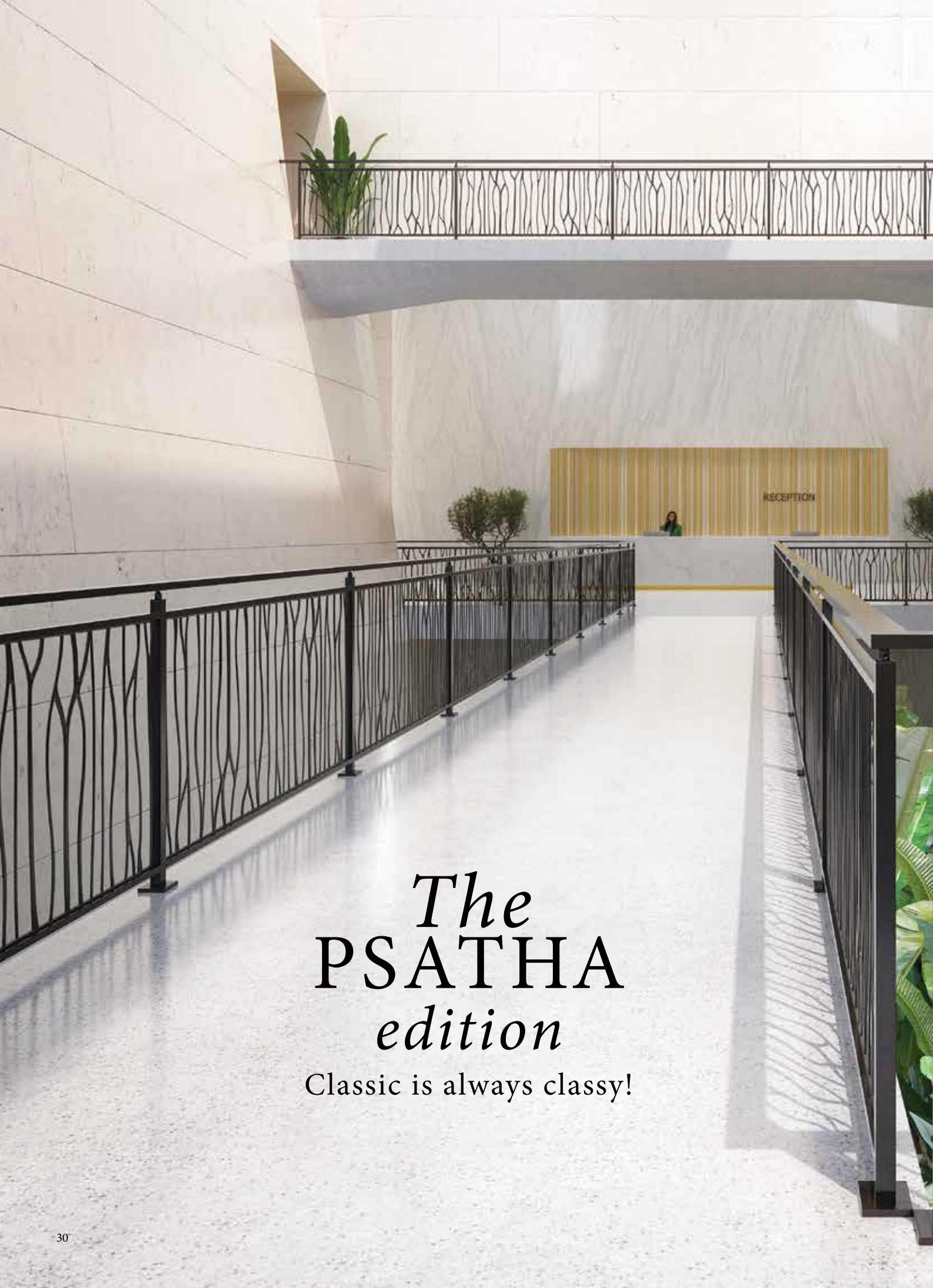

*The*  
PSATHA  
*edition*

Classic is always classy!

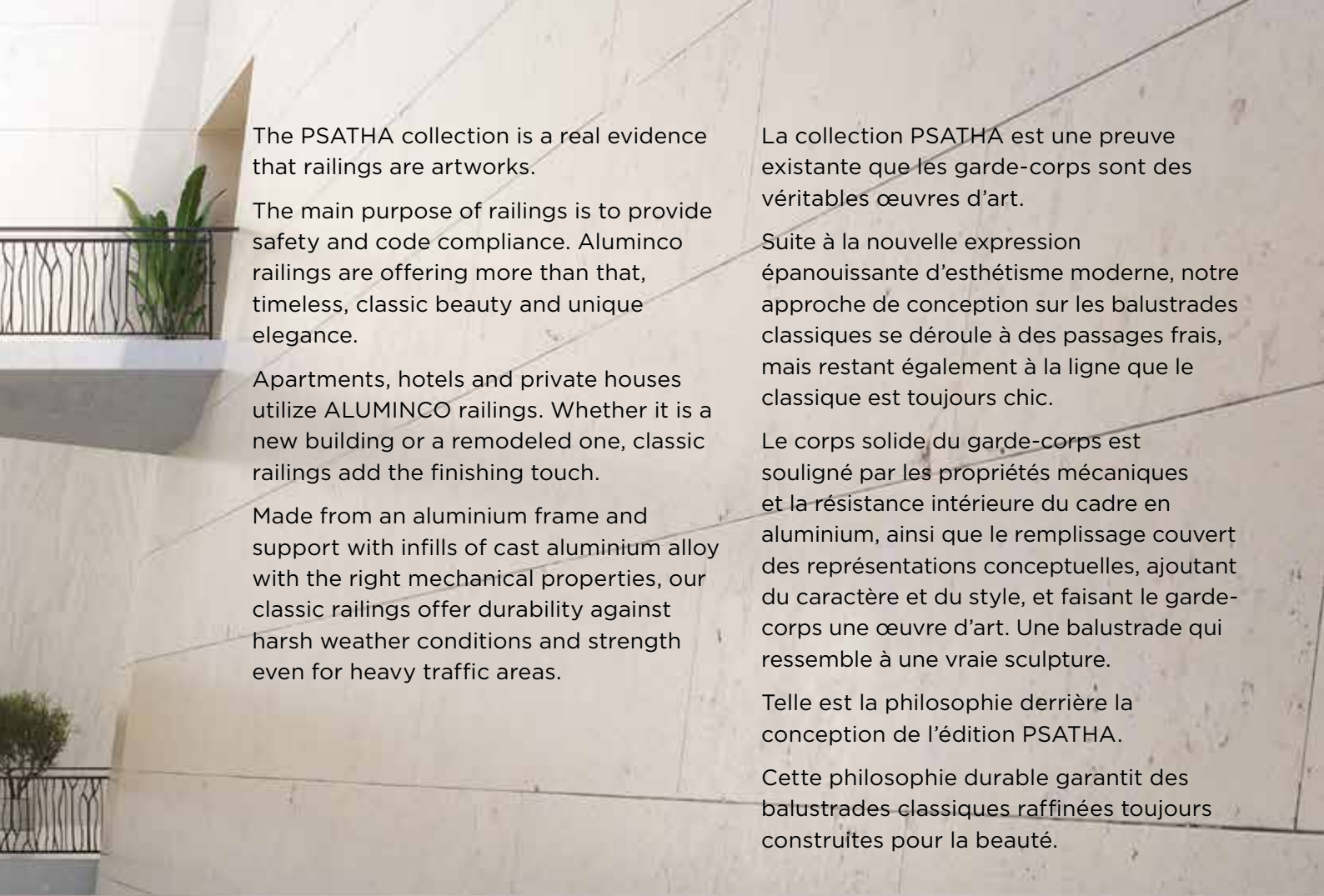

The PSATHA collection is a real evidence that railings are artworks.

The main purpose of railings is to provide safety and code compliance. Aluminco railings are offering more than that, timeless, classic beauty and unique elegance.

Apartments, hotels and private houses utilize ALUMINCO railings. Whether it is a new building or a remodeled one, classic railings add the finishing touch.

Made from an aluminium frame and support with infills of cast aluminium alloy with the right mechanical properties, our classic railings offer durability against harsh weather conditions and strength even for heavy traffic areas.

La collection PSATHA est une preuve existante que les garde-corps sont des véritables œuvres d'art.

Suite à la nouvelle expression épanouissante d'esthétisme moderne, notre approche de conception sur les balustrades classiques se déroule à des passages frais, mais restant également à la ligne que le classique est toujours chic.

Le corps solide du garde-corps est souligné par les propriétés mécaniques et la résistance intérieure du cadre en aluminium, ainsi que le remplissage couvert des représentations conceptuelles, ajoutant du caractère et du style, et faisant le garde-corps une œuvre d'art. Une balustrade qui ressemble à une vraie sculpture.

Telle est la philosophie derrière la conception de l'édition PSATHA.

Cette philosophie durable garantit des balustrades classiques raffinées toujours construites pour la beauté.



Luxury hotel lounge using PSATHA FOREST  
Salon d'hôtel de luxe utilisant PSATHA DASOS



80-28



80-10  
ASTERI B





80-04  
GOTHIC



80-06  
LINEAR 828



80-28

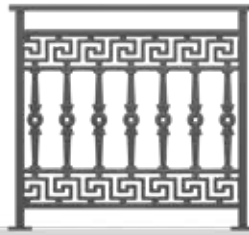

ATHENIAN



COLONIAN

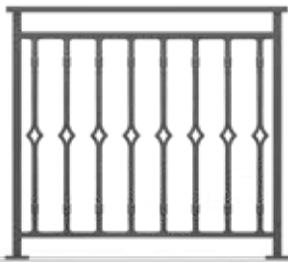

ASTERI A

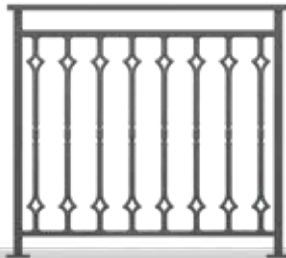

ASTERI B

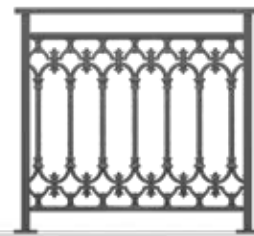

VIENNA

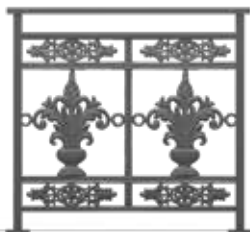

FLOWER POT

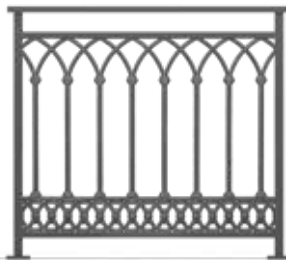

GOTHIC



LINEAR 828

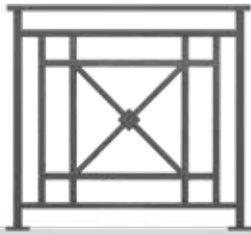

DORIC



ETHNIKIS



ELEPHANTS



ERODIUS

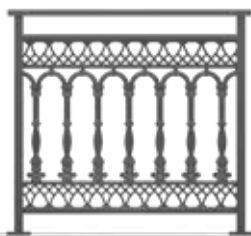

KAMARA



KOLONATO



KYKLADITIKO



MAKRIYIANNI



MINOAN

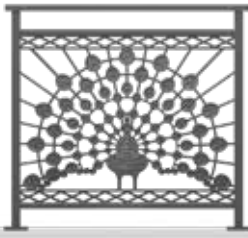

PEAFOWL

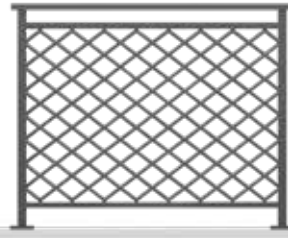

CHIASTI

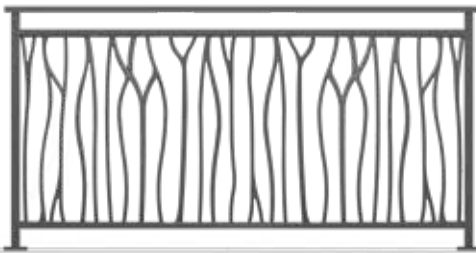

FOREST



ZEFYROS

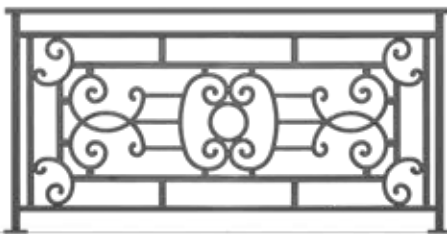

OLYMPIA



PERIKOKLADA





The background features a light gray gradient with faint, white line-art illustrations of architectural profiles. On the left, a dark, solid-colored architectural element is partially visible. The central focus is a large, faint illustration of a classical archway with three columns. The columns have a fluted texture. The arches are supported by decorative brackets with intricate, symmetrical designs. To the right, there is a vertical decorative border with repeating floral or geometric motifs. The overall aesthetic is clean and professional, typical of a technical or architectural catalog.

**PROFILES  
PROFILS**

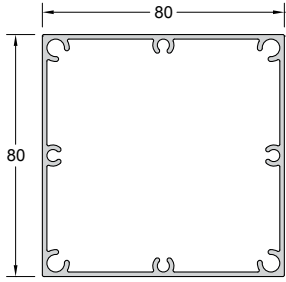

Code: **CLS-100**

WEIGHT / POIDS: 1606 gr/m  
 COLUMN 80x80  
 POTEAU 80x80

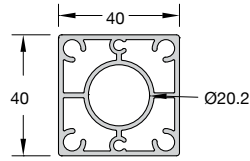

Code: **CLS-102**

WEIGHT / POIDS: 1245 gr/m  
 COLUMN 40x40  
 POTEAU 40x40

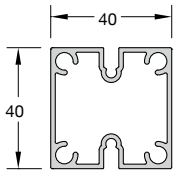

Code: **CLS-103**

WEIGHT / POIDS: 945 gr/m  
 COLUMN 40x40  
 POTEAU 40x40

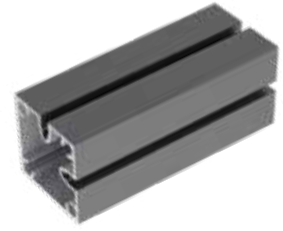
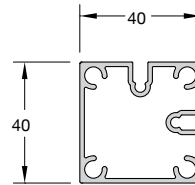

Code: **CLS-104**

WEIGHT / POIDS: 945 gr/m  
 COLUMN 40x40 CORNER  
 POTEAU 40x40 EQUERRE

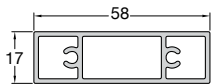

Code: **FSN-302**

WEIGHT / POIDS: 781 gr/m  
 SQUARE 58x17  
 CARRE 58x17

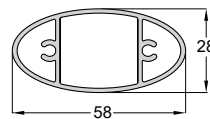

Code: **FSN-304**

WEIGHT / POIDS: 804 gr/m  
 PROFILE OVAL 58X28  
 PROFIL OVALE 58x28



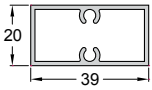

Code: **3200-601**

WEIGHT / POIDS: 502 gr/m  
MULLION PROFILE  
MULLION PROFIL

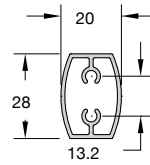

Code: **CLS-304**

WEIGHT / POIDS: 389 gr/m  
INTERNAL COLUMN  
POTEAU INTERNE

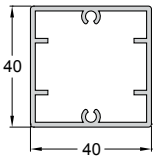

Code: **F50-106**

WEIGHT / POIDS: 794 gr/m  
SUPPORT COLUMN 40x40  
POTEAU 40x40

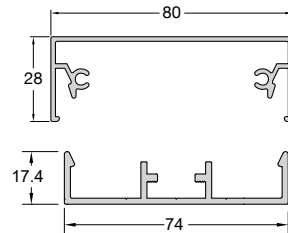

Code: **CLS-201**

WEIGHT / POIDS: 757 gr/m  
HANDRAIL 30x80  
MAIN COURANTE 30x80

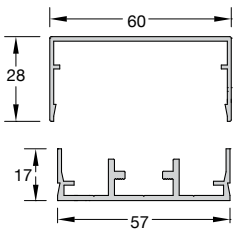

Code: **CLS-301**

WEIGHT / POIDS: 588 gr/m  
GUIDE  
GUIDAGE

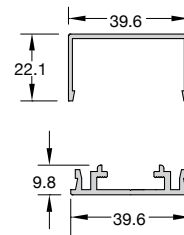

Code: **CLS-302**

WEIGHT / POIDS: 359 gr/m  
GUIDE  
GUIDAGE

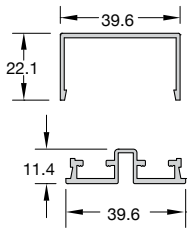

Code: **CLS-303**

WEIGHT / POIDS: 348 gr/m  
GUIDE  
GUIDAGE

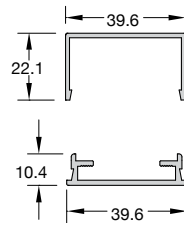

Code: **CLS-306**

WEIGHT / POIDS: 311 gr/m  
GUIDE FOR FENCE RAILING  
GUIDAGE POUR CLOTURE

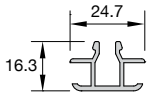

Code: **CLS-307**

WEIGHT / POIDS: 262 gr/m  
GUIDE FOR AL-FLEX  
GUIDAGE POUR AL-FLEX

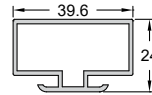

Code: **CLS-308**

WEIGHT / POIDS: 528 gr/m  
GUIDE FOR AL-FLEX  
GUIDAGE POUR AL-FLEX

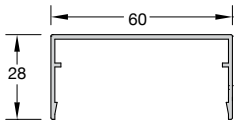

Code: **CLS-3K1**

WEIGHT / POIDS: 450 gr/m  
COVER FOR GUIDE CLS-301  
CAPUCHON POUR GUIDAGE CLS-301

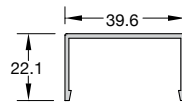

Code: **CLS-3K2**

WEIGHT / POIDS: 324 gr/m  
COVER FOR GUIDE CLS-302  
CAPUCHON POUR GUIDAGE CLS-302

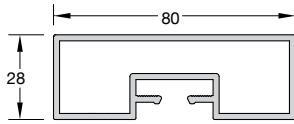

Code: **CLS-202**

WEIGHT / POIDS: 1360 gr/m  
 HANDRAIL 80x28  
 MAIN COURANTE 80x28

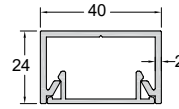

Code: **823**

WEIGHT / POIDS: 751 gr/m  
 CLIPPED GUIDE 24x40  
 GUIDAGE AVEC CLIP 24x40

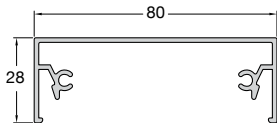

Code: **FSN-221**

WEIGHT / POIDS: 754 gr/m  
 COVER FOR HANDRAIL 80x28  
 COUVERCLE POUR MAIN COURANTE 80x28

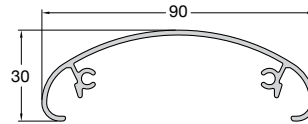

Code: **FSN-222**

WEIGHT / POIDS: 736 gr/m  
 COVER FOR HANDRAIL OVAL 90x30  
 COUVERCLE POUR MAIN COURANTE OVALE 90x30

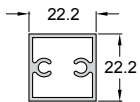

Code: **PAT05-003**

WEIGHT / POIDS: 369 gr/m  
 RECTANGULAR 22x22  
 CARRE 22x22



The background features a vertical gradient from light to dark grey. On the left, there is a large, faint architectural drawing of a Gothic-style window or screen with three columns and pointed arches. On the right, there is a vertical strip with a repeating pattern of decorative finials or moldings.

**ACCESSORIES  
ACCESSOIRES**

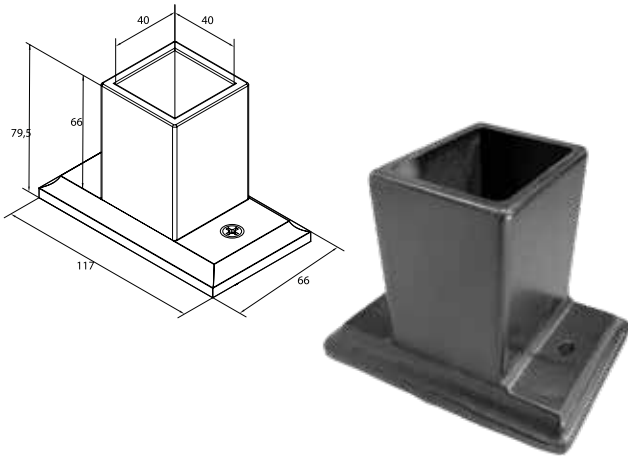

Code: **4113**  
 SUPPORT FOOT FOR COLUMN 40x40  
 SABOT DE POTEAU 40x40

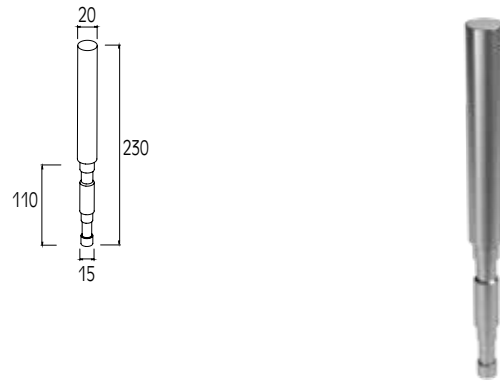

Code: **4188**  
 INFLOOR SUPPORT FOR F50-102 COLUMN  
 FIXATION ENCASTRE DE POTEAU F50-102

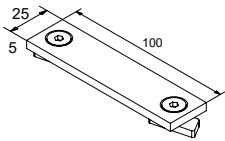

Code: **4261**  
 HANDRAIL CONNECTOR HORIZONTAL  
 JONCTION DE MAIN COURANTE (DROIT)

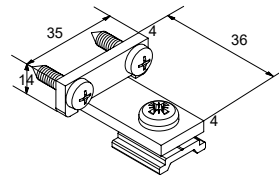

Code: **4270**  
 CONNECTOR FOR CLS-201/301/302/305  
 JONCTION POUR CLS-201/301/302/305

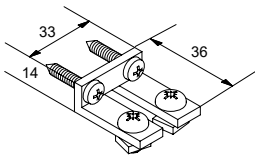

Code: **4271**  
 CONNECTOR FOR GUIDE CLS-303  
 JONCTION POUR GUIDAGE CLS-303

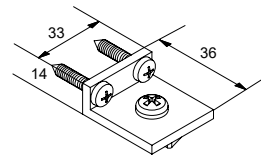

Code: **4272**  
 CONNECTOR FOR GUIDE CLS-306  
 JONCTION POUR GUIDAGE CLS-306

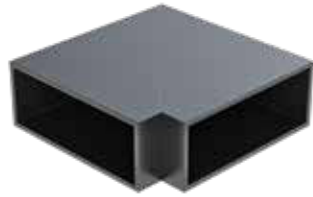
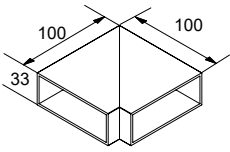

Code: **4273**  
 CORNER CONNECTOR FOR CLS-201/FSN-221  
 JONCTION EN ANGLE POUR CLS-201/FSN-221

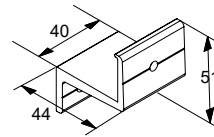

Code: **4274**  
 EXTERNAL PSATHA SUPPORT  
 SUPPORT POUR PSATHA

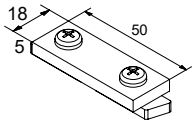

Code: **4275**  
 CONNECTOR FOR GUIDE CLS-302  
 JONCTION POUR GUIDAGE CLS-302

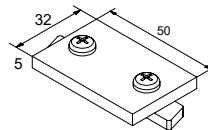

Code: **4276**  
 CONNECTOR FOR GUIDE CLS-306  
 JONCTION POUR GUIDAGE CLS-306

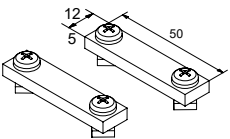

Code: **4278**  
 CONNECTOR FOR GUIDE CLS-303  
 JONCTION POUR GUIDAGE CLS-303

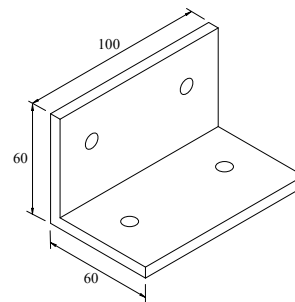

Code: **4282**  
 WALL SUPPORT FOR COLUMN CLS-102  
 FIXATION MURALE DE POTEAU CLS-102

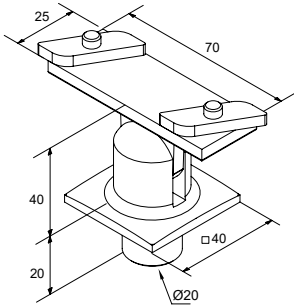

Code: **4345**

CONNECTOR FOR CLS-102 COLUMN WITH F50-201  
HANDRAIL  
JONCTION DE MAIN COURANTE CLS-102 AVEC POTEAU  
F50-201

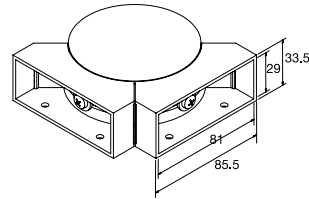

Code: **4375**

ADJUSTABLE CORNER CONNECTOR FOR HANDRAIL CLS-  
201/FSN-221  
JONCTION ANGULAIRE DE MAIN COURANTE CLS-201/FSN-  
221

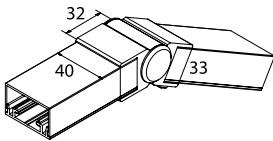

Code: **4376**

CONNECTOR FOR GUIDE CLS-3K2/302  
JONCTION DE GUIDAGE CLS-3K2/302

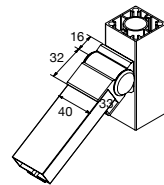

**E4377  
UP  
AL-FLEX**

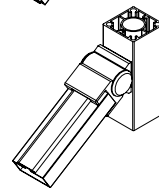

**E4377  
DOWN  
AL-FLEX**



Code: **4377**

CONNECTOR FOR GUIDE CLS-3K2 WITH COLUMN CLS-102  
JONCTION DE GUIDAGE CLS-3K2 AVEC POTEAU CLS-102

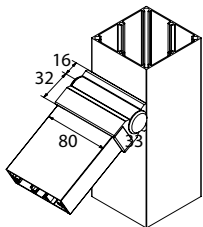

Code: **4378**

CONNECTOR FOR HANDRAIL FSN-221 WITH COLUMN CLS-  
100  
JONCTION DE MAIN COURANTE FSN-221 AVEC POTEAU  
CLS-100

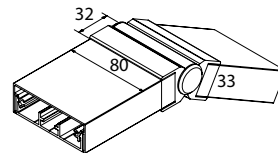

Code: **4379**

ADJUSTABLE CONNECTOR FOR HANDRAIL CLS-202  
JONCTION DE MAIN COURANTE CLS-202



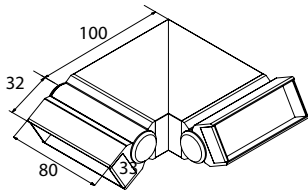

Code: **4384**

ADJUSTABLE CORNER CONNECTOR 90° FOR CLS-202  
HANDRAIL (STAIRS)  
JONCTION ANGULAIRE 90° DE POTEAU CLS-202  
(ESCALIER)

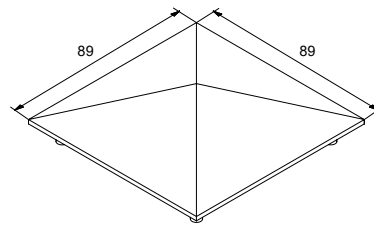

Code: **4485**

COVER FOR COLUMN CLS-100  
BOUCHON DE POTEAU CLS-100

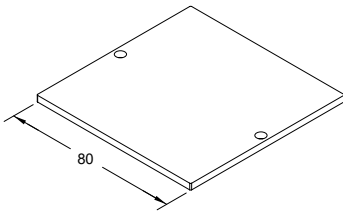

Code: **4486**

END CAP FOR COLUMN CLS-100 (80x80) FLAT  
EMBOUT DE POTEAU CLS-100 (80x80) PLAT

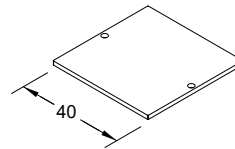

Code: **4487**

END CAP FOR COLUMN CLS-102 (40x40) FLAT  
EMBOUT DE POTEAU CLS-102 (40x40) PLAT

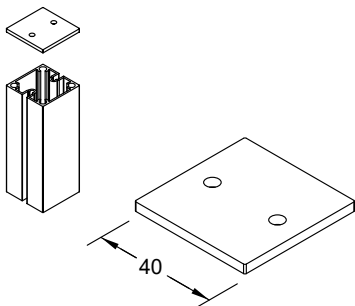

Code: **4489**

END CAP FOR COLUMN CLS-103 (40x40) FLAT  
EMBOUT DE POTEAU CLS-103 (40x40) PLAT

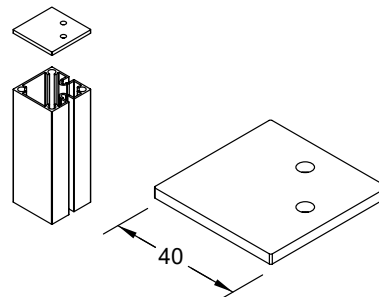

Code: **4490**

END CAP FOR COLUMN CLS-104 (40x40) FLAT  
EMBOUT DE POTEAU CLS-104 (40x40) PLAT

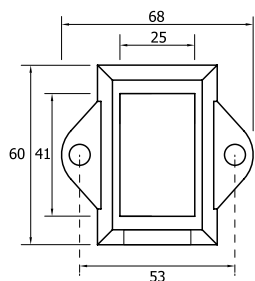

Code: **4504**

WALL COVER FOR GUIDE 823 (24x40)  
CACHE DU MUR DE GUIDAGE 823 (24x40)



Code: **4507**

WALL COVER FOR COLUMN 40x40  
CACHE DU MUR DE POTEAU 40x40

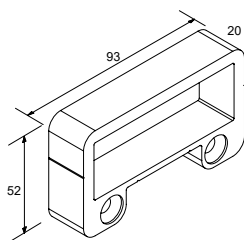

Code: **4525**

WALLCOVER FOR HANDRAIL CLS-202/201  
CACHE DU MUR POUR COURANTE CLS-202/201

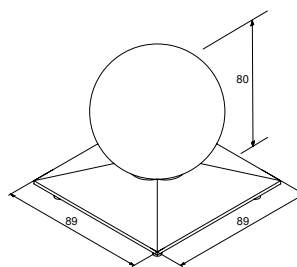

Code: **4621**

COVER WITH THIRSUS FOR COLUMN CLS-100  
BOUCHON AVEC THYRSUS DE POTEAU CLS-100

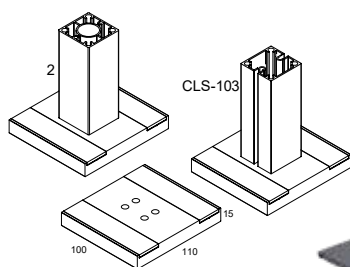

Code: **4723**

SUPPORT FOOT FOR COLUMN CLS-102  
SABOT DE POTEAU CLS-102

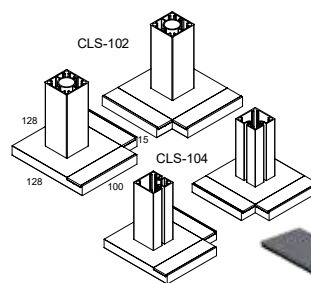

Code: **4724**

SUPPORT FOOT FOR COLUMN CLS-102  
SABOT DE POTEAU CLS-102

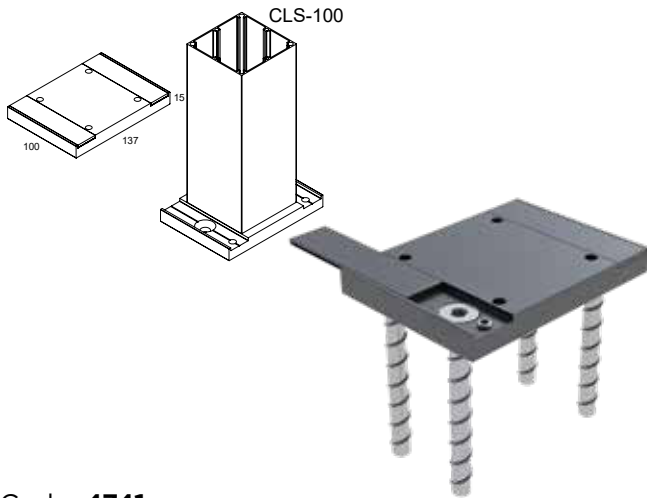

Code: **4741**

SUPPORT FOOT FOR COLUMN CLS-100 WITH 4 CONCRETE  
SCREWS  
SABOT DE POTEAU CLS-100 AVEC 4 VIS

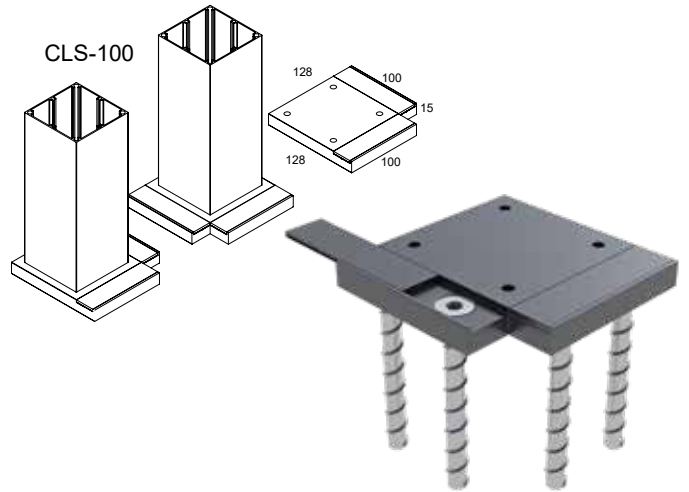

Code: **4742**

SUPPORT FOOT FOR COLUMN CLS-100 WITH 4 CONCRETE  
SCREWS  
SABOT DE POTEAU CLS-100 AVEC 4 VIS

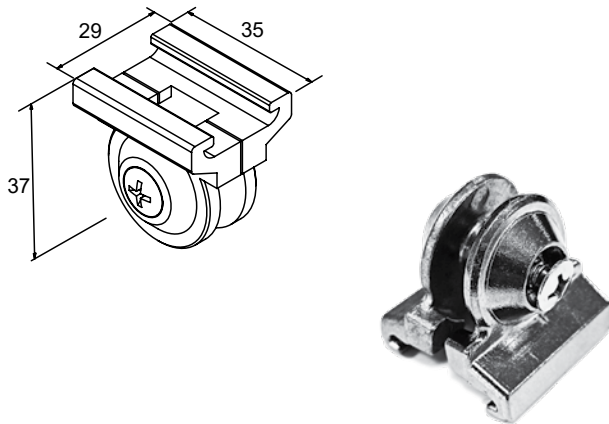

Code: **22**

AL-FLEX HEAD ATTACHMENT FOR GUIDE  
AL-FLEX CHAPEAU DECORATIF DE GUIDAGE

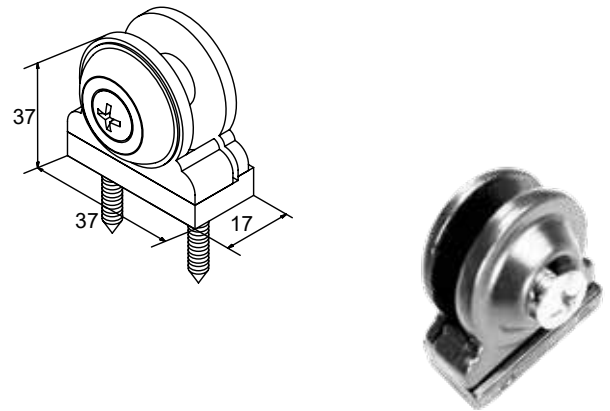

Code: **24**

AL-FLEX HEAD ATTACHMENT  
AL-FLEX CHAPEAU DECORATIF



The background features a light gray Gothic architectural pattern. It consists of three vertical columns with a ribbed texture, topped and bottomed by decorative arches with pointed, leaf-like details. The word "COMBINATIONS" is centered in a bold, black, serif font.

# COMBINATIONS

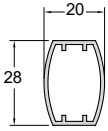

Code: **828**

WEIGHT / POIDS: 313 gr/m

COLUMN 28x20

POTEAU 28x20

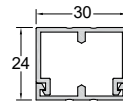

Code: **831**

WEIGHT / POIDS: 508 gr/m

DRILLED GUIDE FOR PROFILE 828

GUIDAGE PERFORE POUR PROFIL 828



Code: **239**

SPIKE FOR FENCE (77X22)

LANCE DE CLOTURE (77X22)

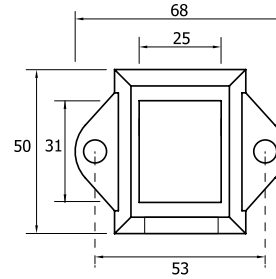

Code: **4503**

WALL COVER FOR GUIDE

CACHE DU MUR POUR GUIDAGE



Code: **240**

SPIKE FOR FENCE FOR PROFILE 828

LANCE DE CLOTURE DE PROFIL 828

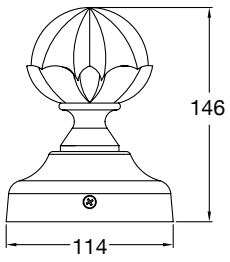

Code: **4613**

COVER WITH THIRSUS FOR COLUMN 100X100  
BOUCHON AVEC THYRSOS DE POTEAU 100X100

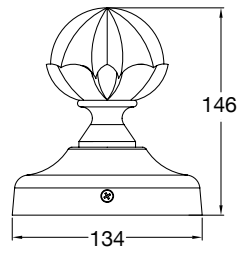

Code: **4614**

COVER WITH THIRSUS FOR COLUMN 120X120  
BOUCHON AVEC THYRSOS DE POTEAU 120X120

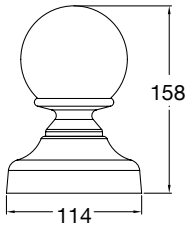

Code: **4616**

COVER WITH GLOBAL THIRSUS FOR COLUMN 100X100  
BOUCHON AVEC THYRSOS ROND DE POTEAU 100X100

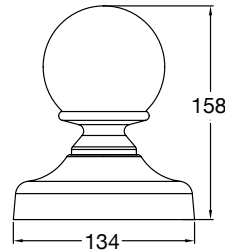

Code: **4617**

COVER WITH GLOBAL THIRSUS FOR COLUMN 120X120  
BOUCHON AVEC THYRSOS ROND DE POTEAU 120X120

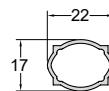

Code: **121**

HEAD ATTACHMENT FOR PROFILE 104  
CHAPEAU DECORATIF DE PROFIL 104



Code: **104**

WEIGHT / POIDS: 197 gr/m  
COLUMN FOR AL-FLEX 22x17  
POTEAU POUR AL-FLEX 22x17

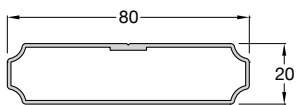

Code: **822**

WEIGHT / POIDS: 629 gr/m  
PROFILE FOR FENCE 80x20  
PROFIL POUR CLOTURE 80x20

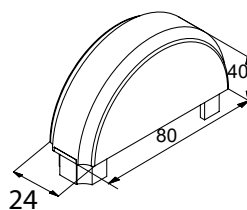

Code: **4410**

END CAP FOR PROFILE 822  
EMBOUT DE PROFIL 822



Code: **178**

KLARA 78CM  
KLARA 78CM



Code: **179**

PERIKOKLADA 95CM  
PERIKOKLADA 95CM



Code: **180**

KLARA 54CM  
KLARA 54CM



Code: **217**

KLARA DOUBLE 82CM  
KLARA DOUBLE 82CM





Code: **65**  
CAPITAL OF PILLAR  
CHAPITEAU



Code: **69**  
COVER FOR COLUMN (165x155)  
BOUCHON DE POTEAU (165x155)



Code: **66**  
BASE FOR COLUMN (30x16cm)  
BASE DE POTEAU (30x16cm)

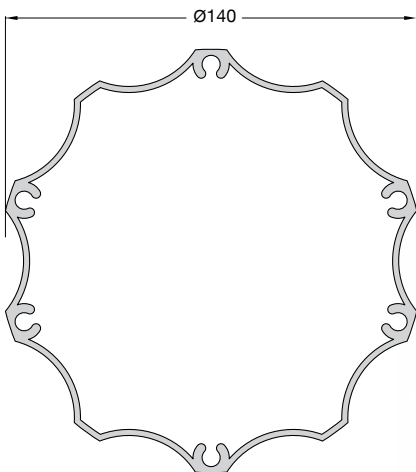

Code: **67**  
WEIGHT / POIDS: 3153 gr/m  
COLUMN 140x140  
POTEAU 140x140

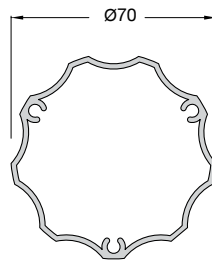

Code: **70**  
WEIGHT / POIDS: 1229 gr/m  
COLUMN 70x70  
POTEAU 70x70









320 11 Inofita Viotia, Greece

T. +30 22620 47000

F. +30 22620 47090

[www.aluminco.com](http://www.aluminco.com)

[info@aluminco.com](mailto:info@aluminco.com)

Version 05/2022

This catalogue supersedes all previous ones