

Wall + deco

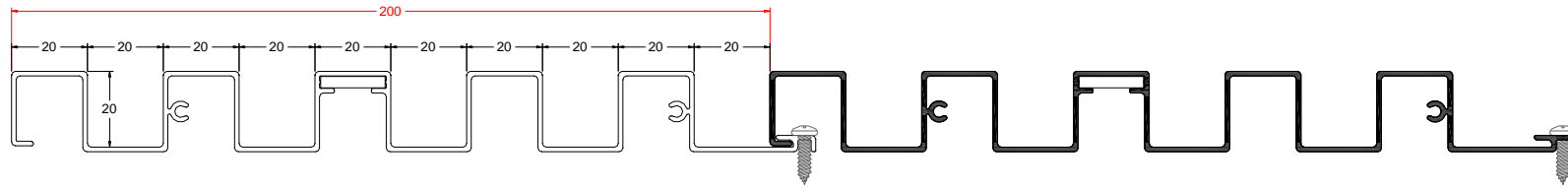

Square type 20x20mm



Profile thickness 1.2mm

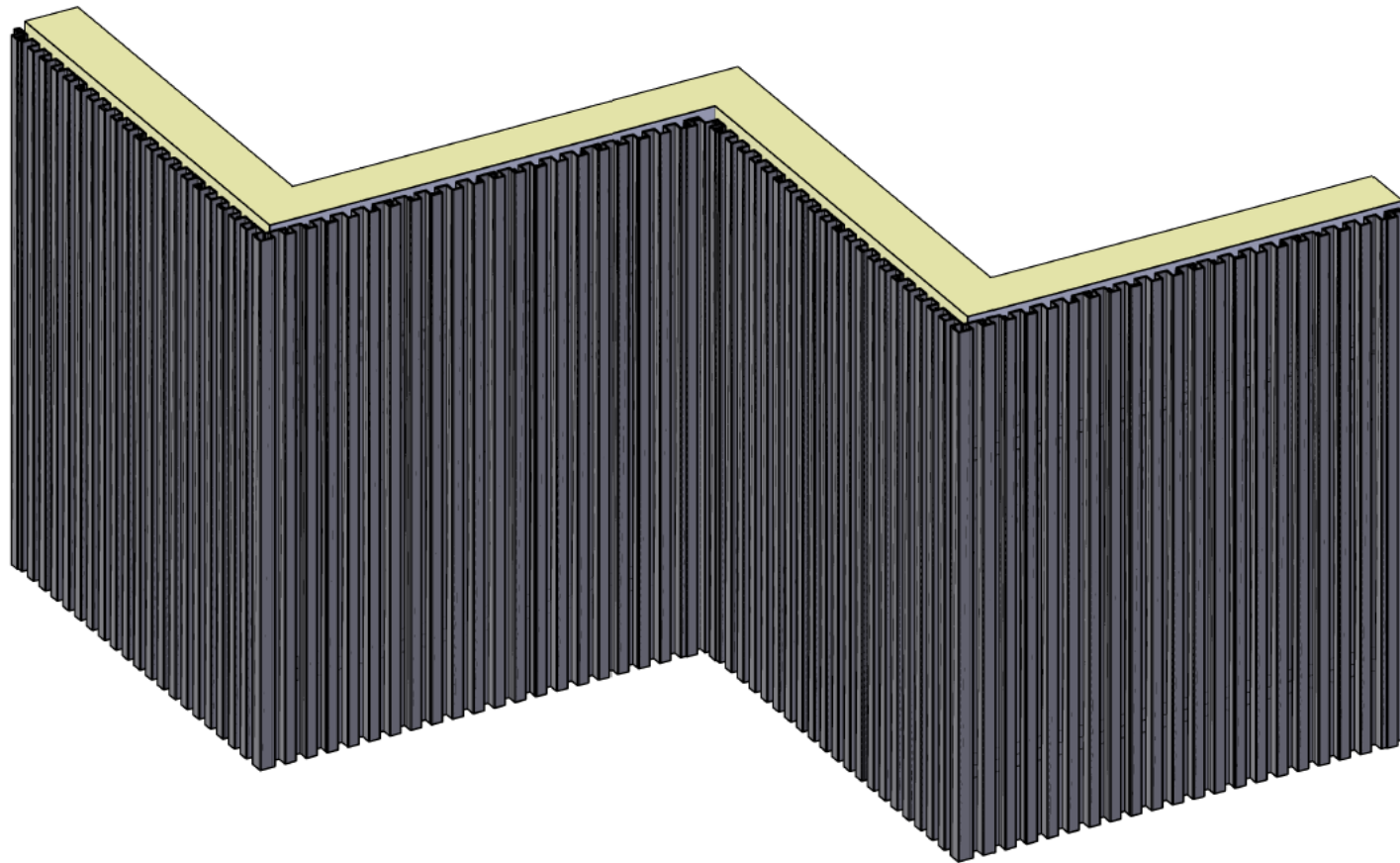

WD_2020

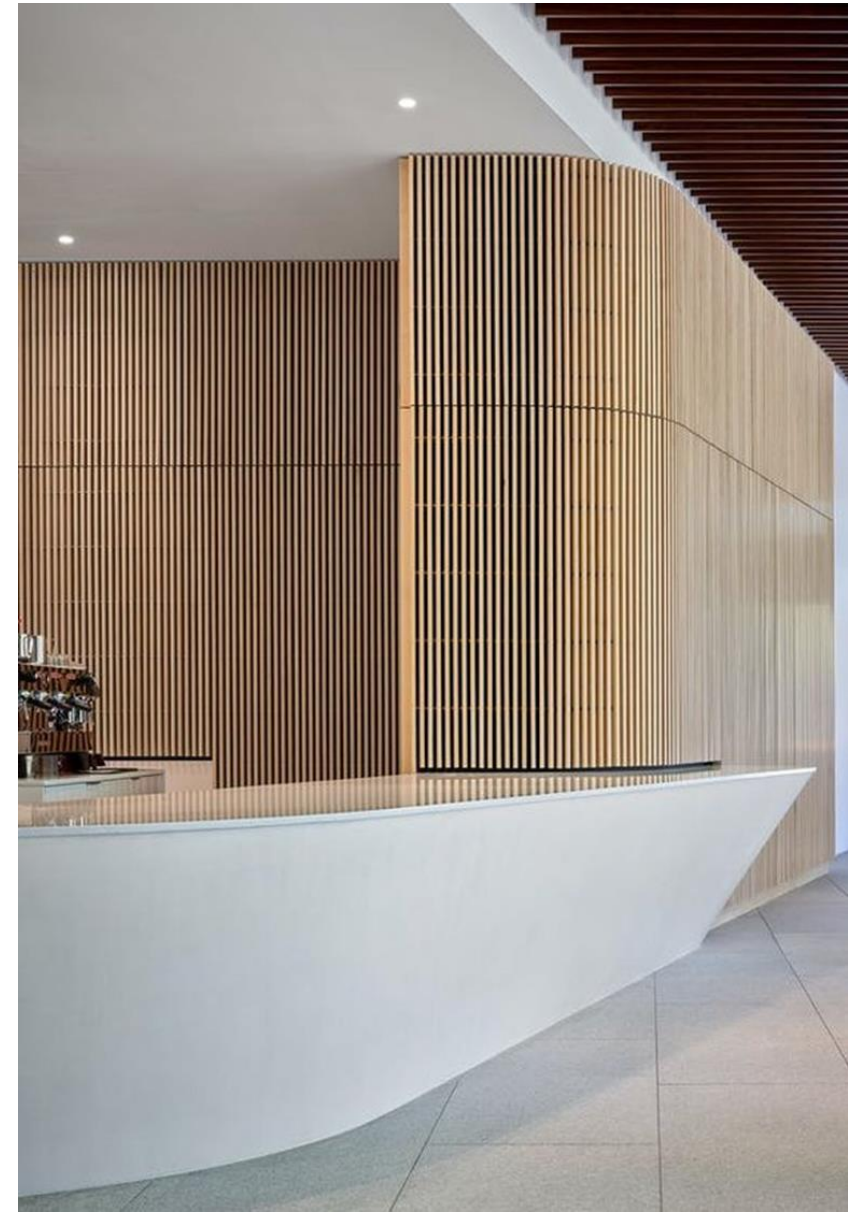

Square type 20x20mm WD_2020

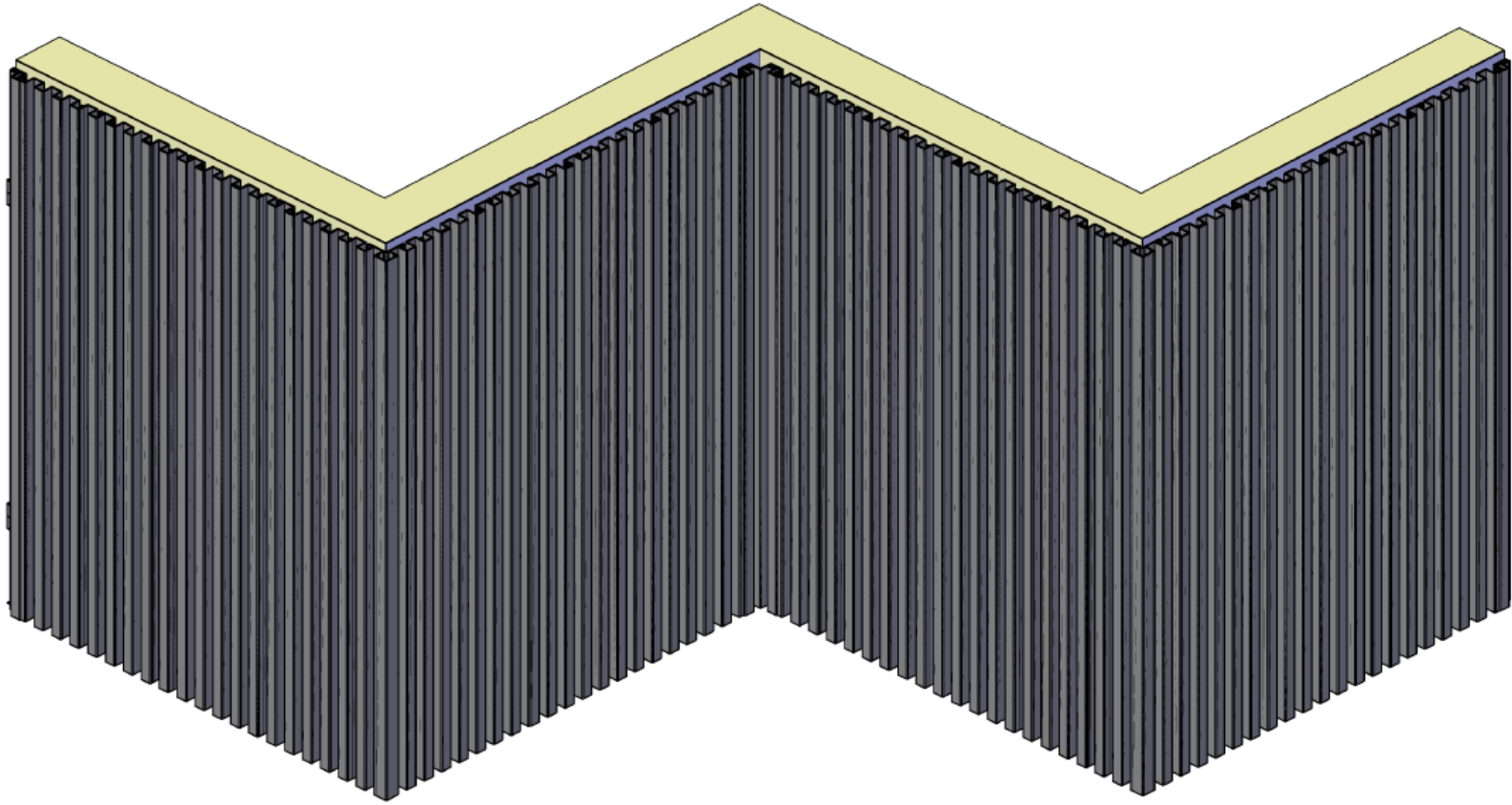

Square type 30x20mm

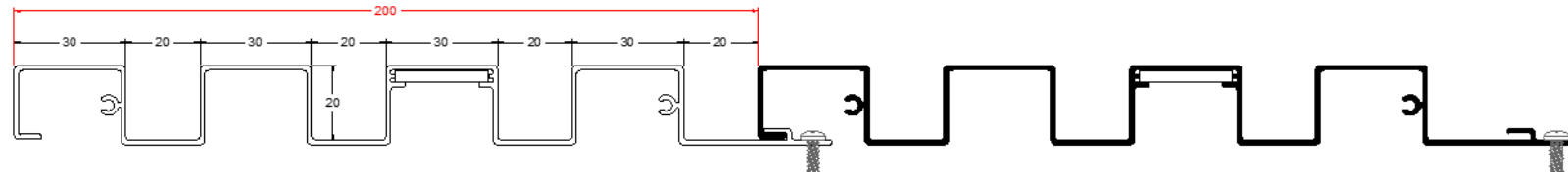

Profile thickness 1.2mm

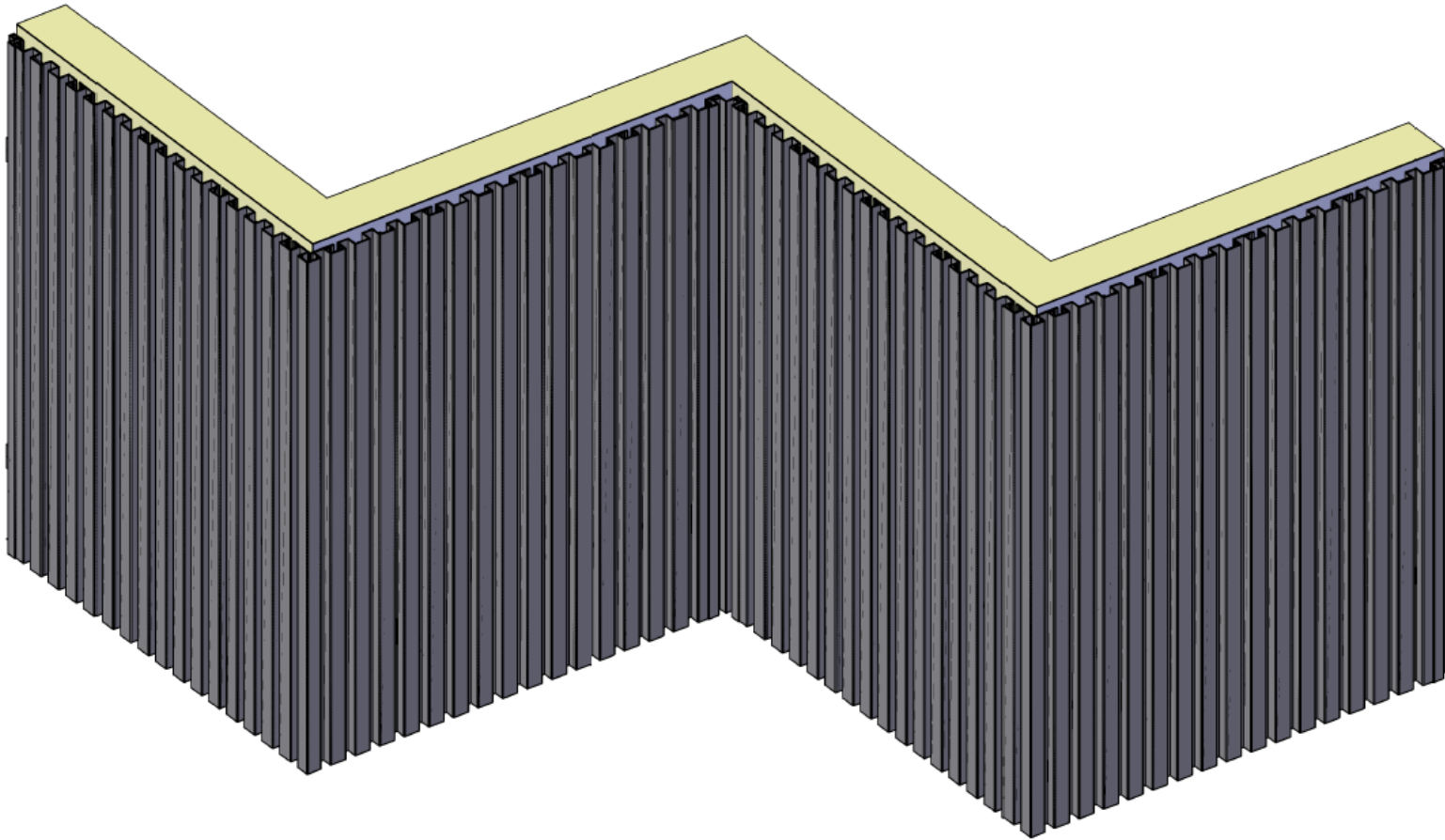

WD_3020



Square type 30x20mm WD_3020

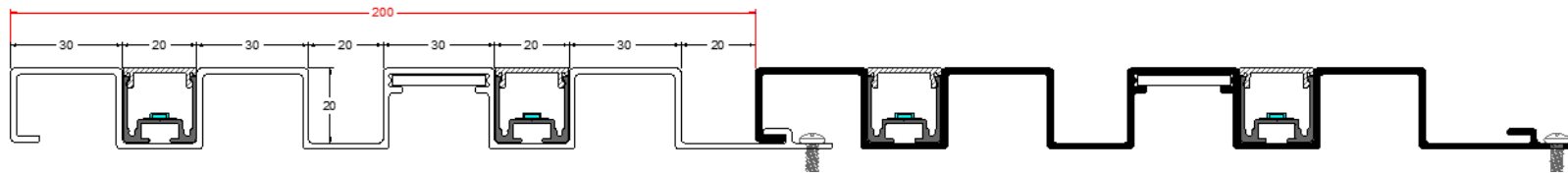

Profile thickness 1.6mm

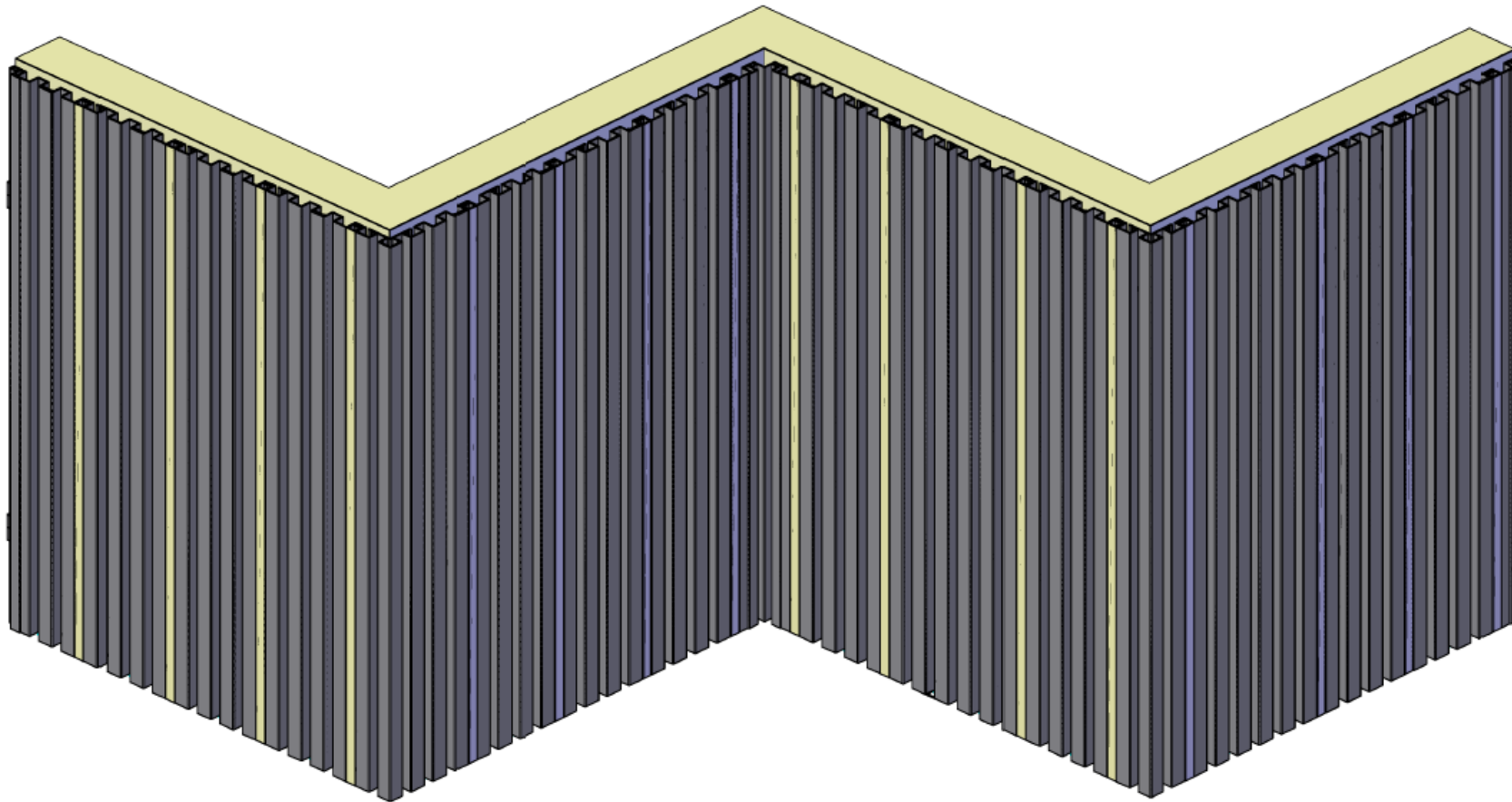

WD_3020



Square type 40x20mm

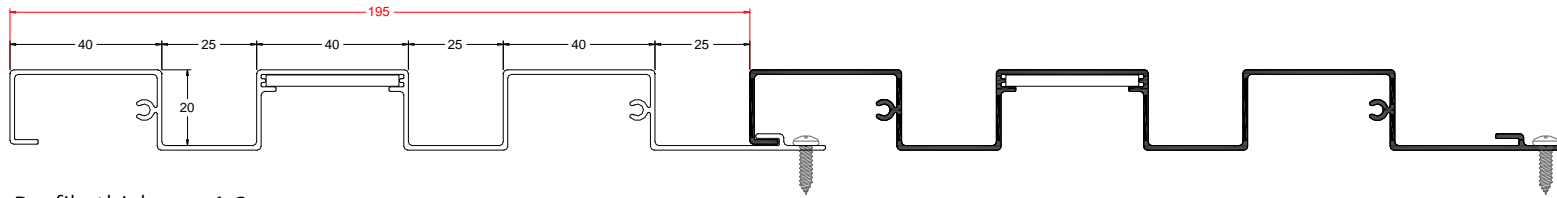

Profile thickness 1.2mm

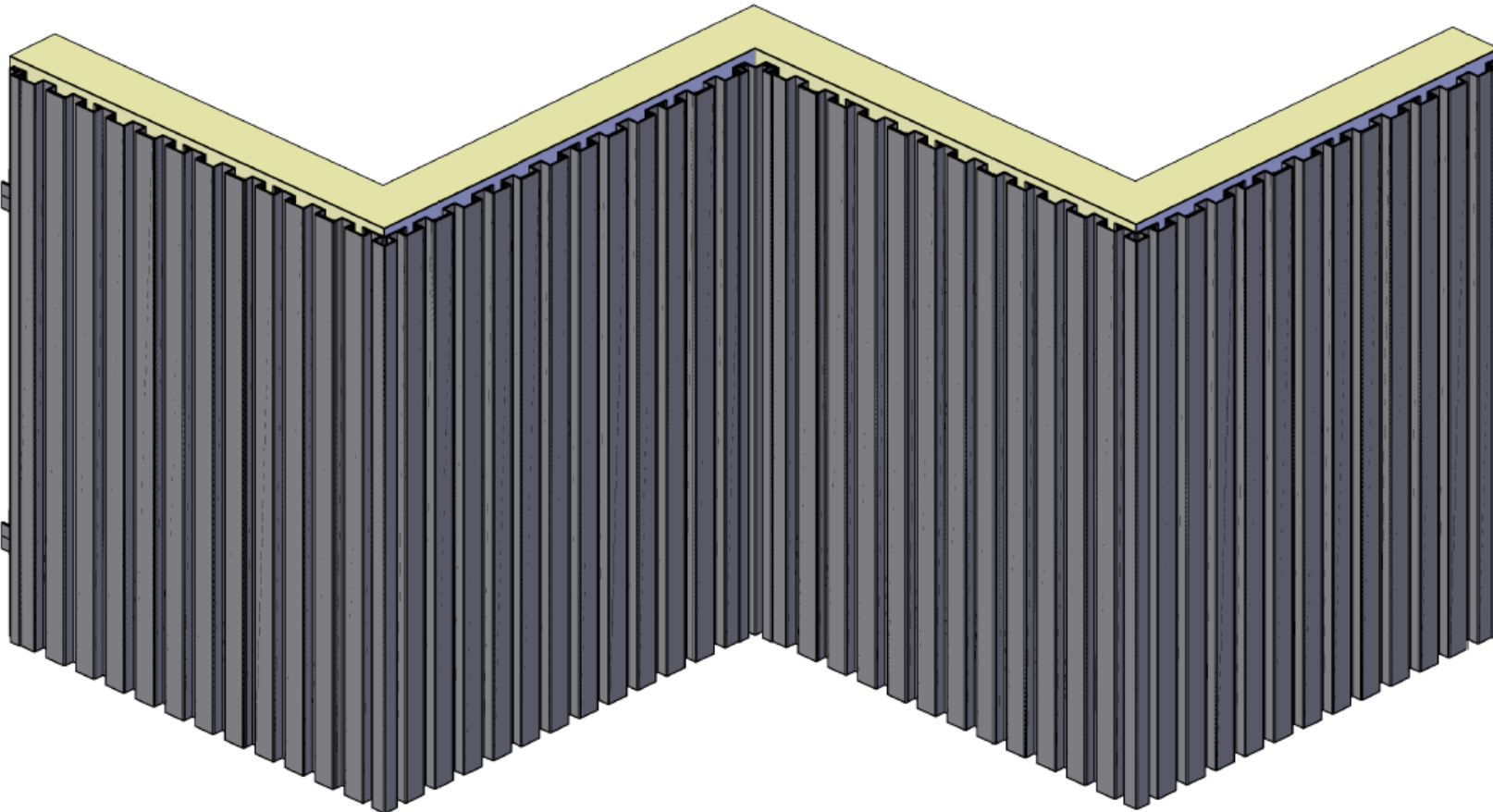

WD_4020



Square type 40x20mm WD_4020

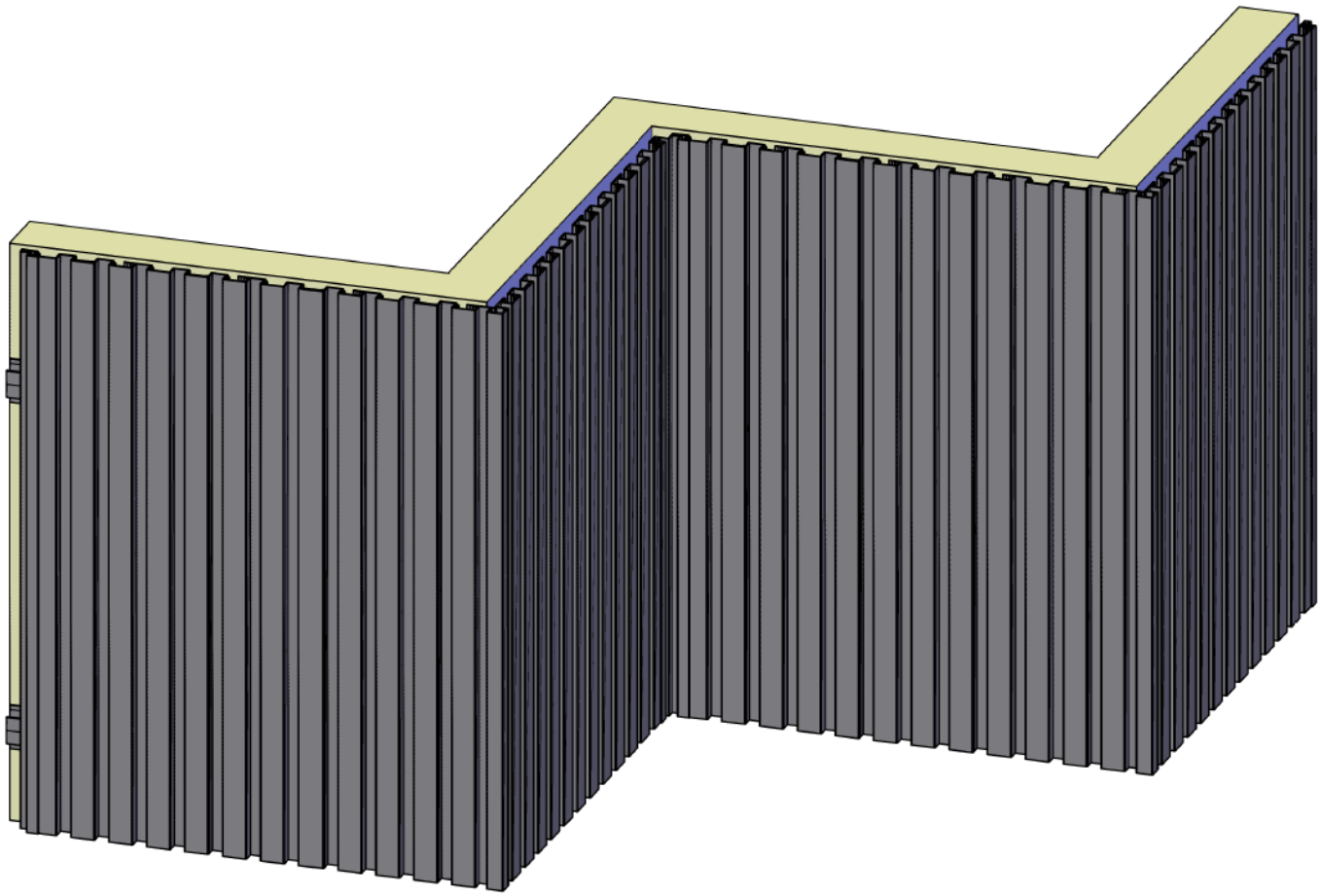

Square type 40x20mm / 40x50mm / 30x30mm

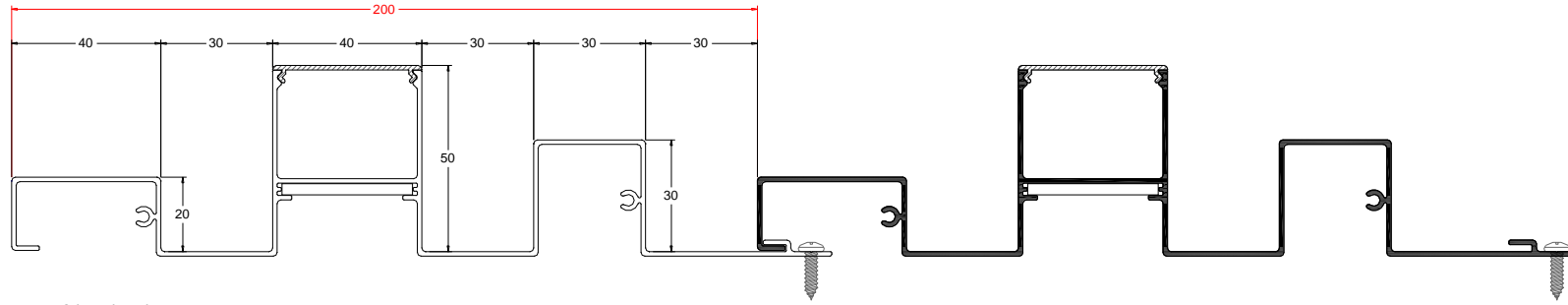

Profile thickness 1.2mm

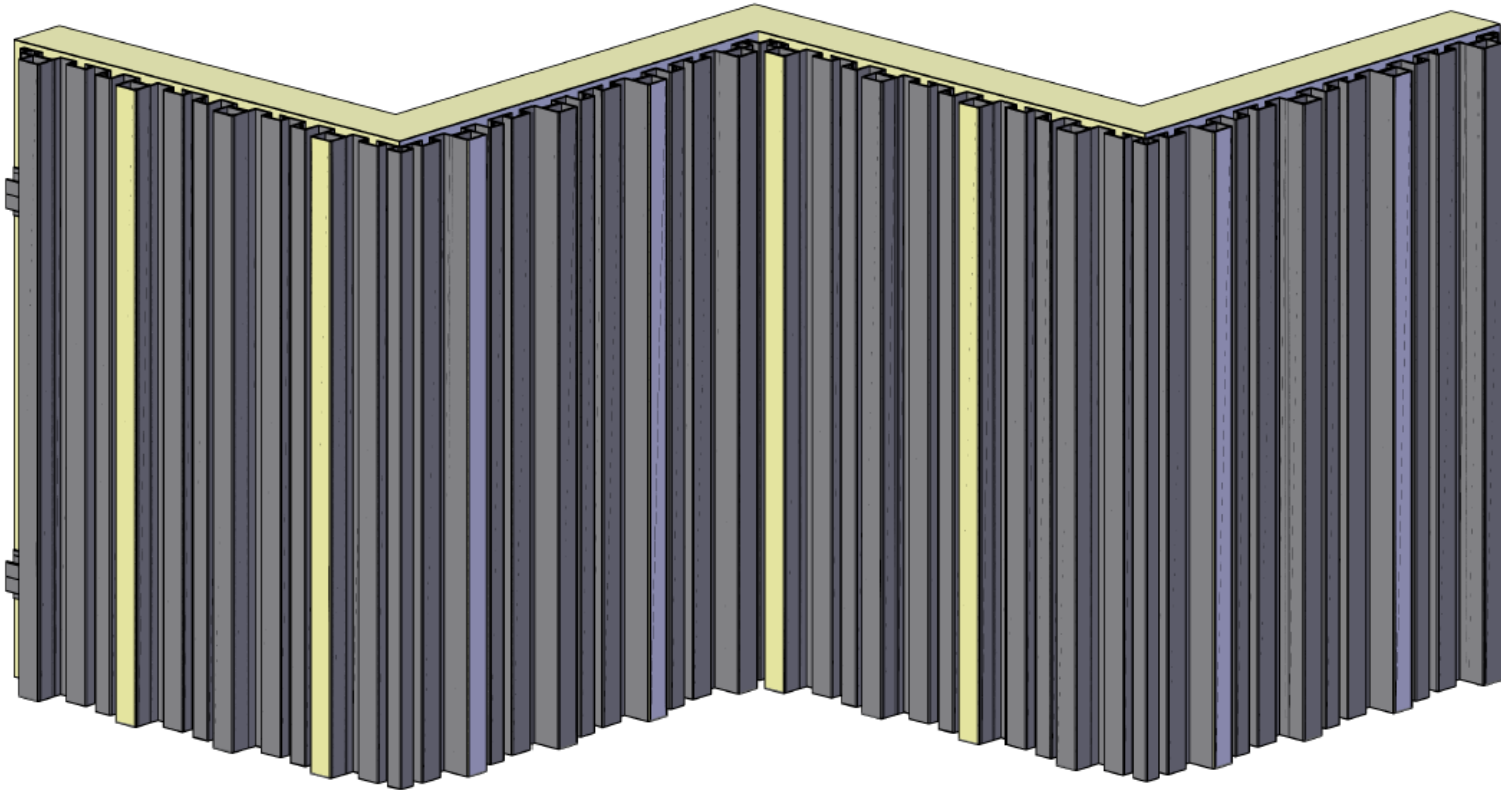

WD_4050



Square type 40x20mm / 40x50mm / 30x30mm WD_4050

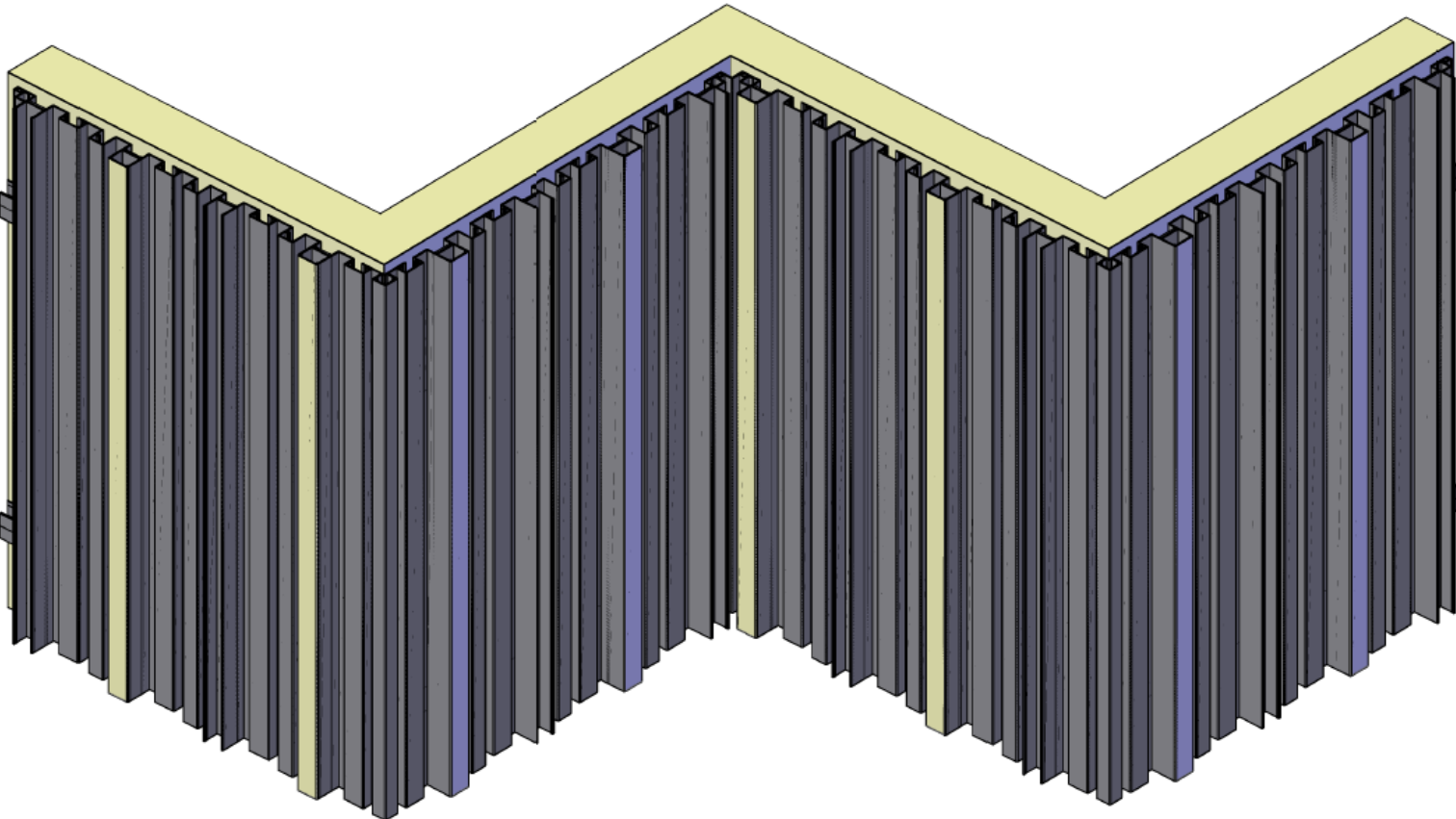

Square type 40x20mm / 40x50mm / 30x30mm WD_4050

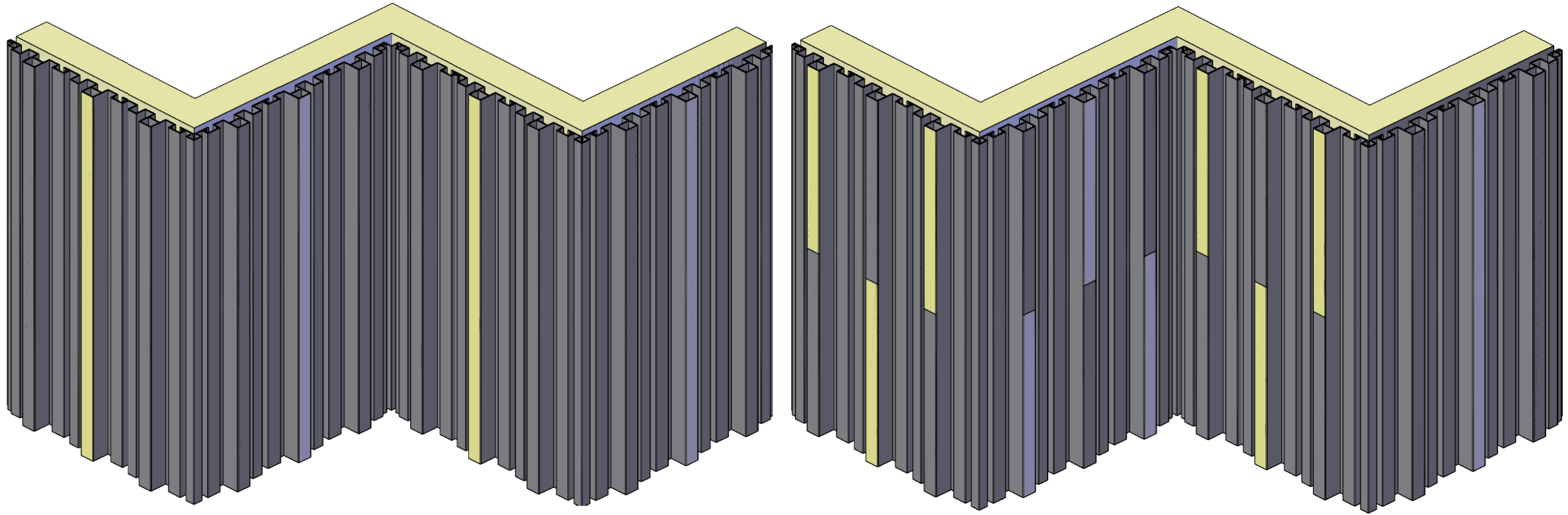

Linear Flat type 195x21.2mm / 20mm gap / 150mm visible profile

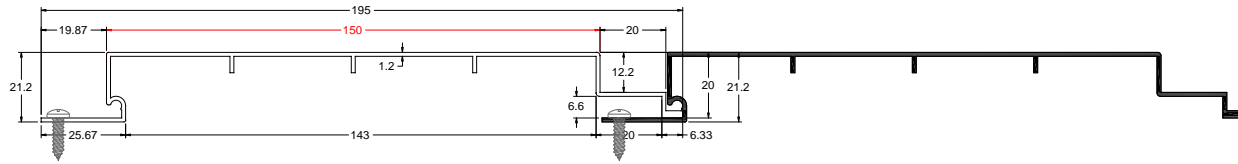

PF_070-015

Profile thickness 1.2-2.2mm

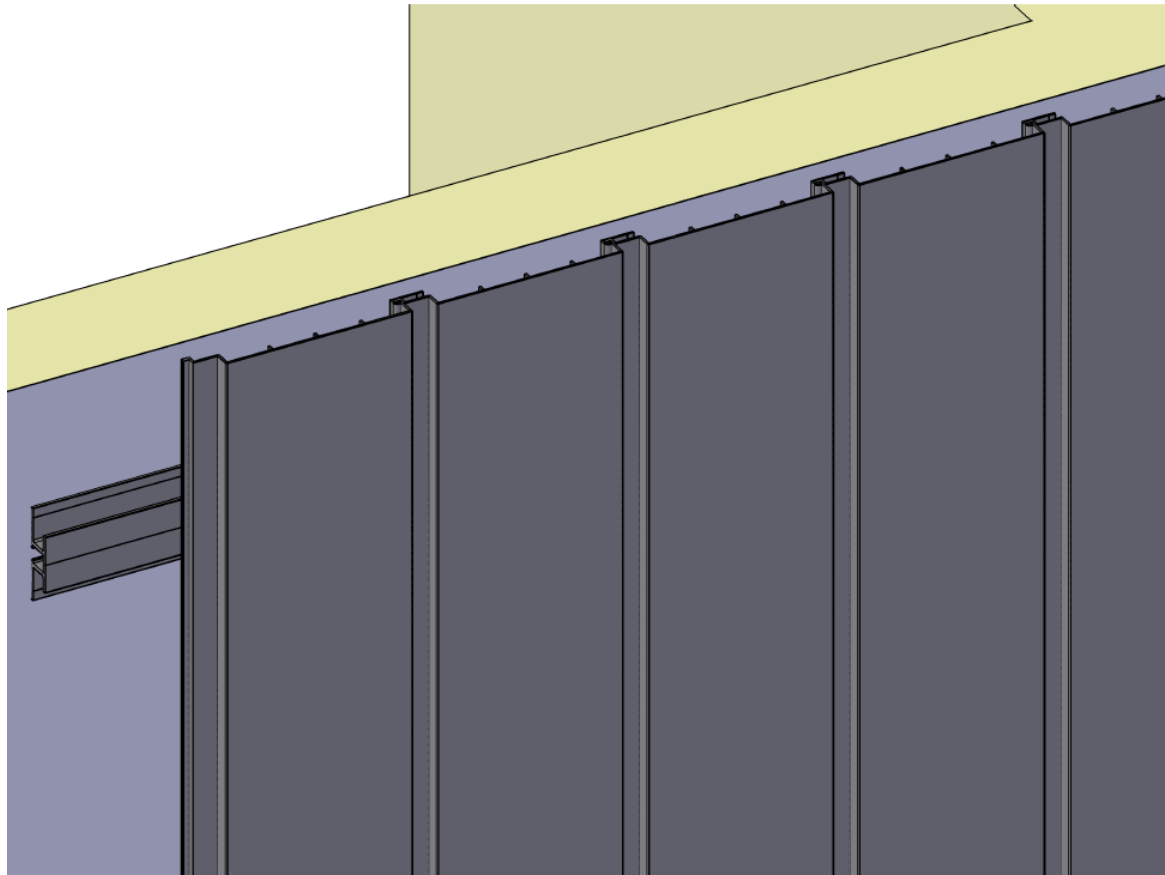

Linear Flat type 245x21.8mm / 20mm gap / 200mm visible profile

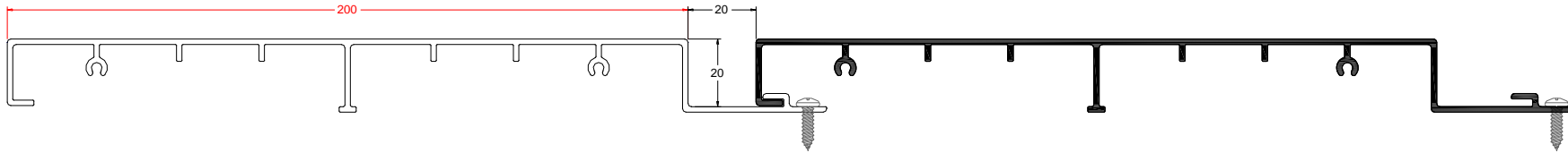

Profile thickness 1,6mm

WD_200

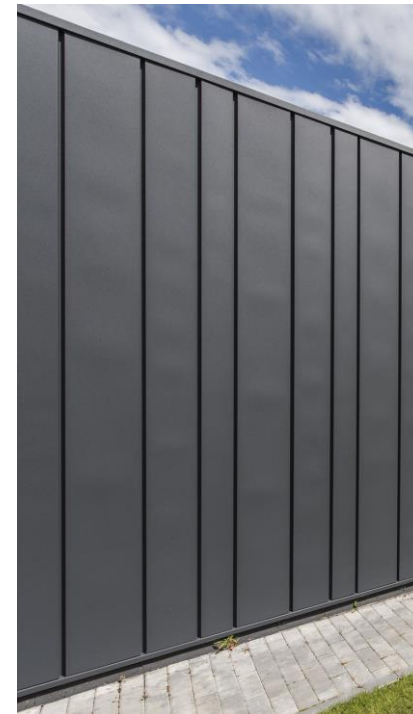
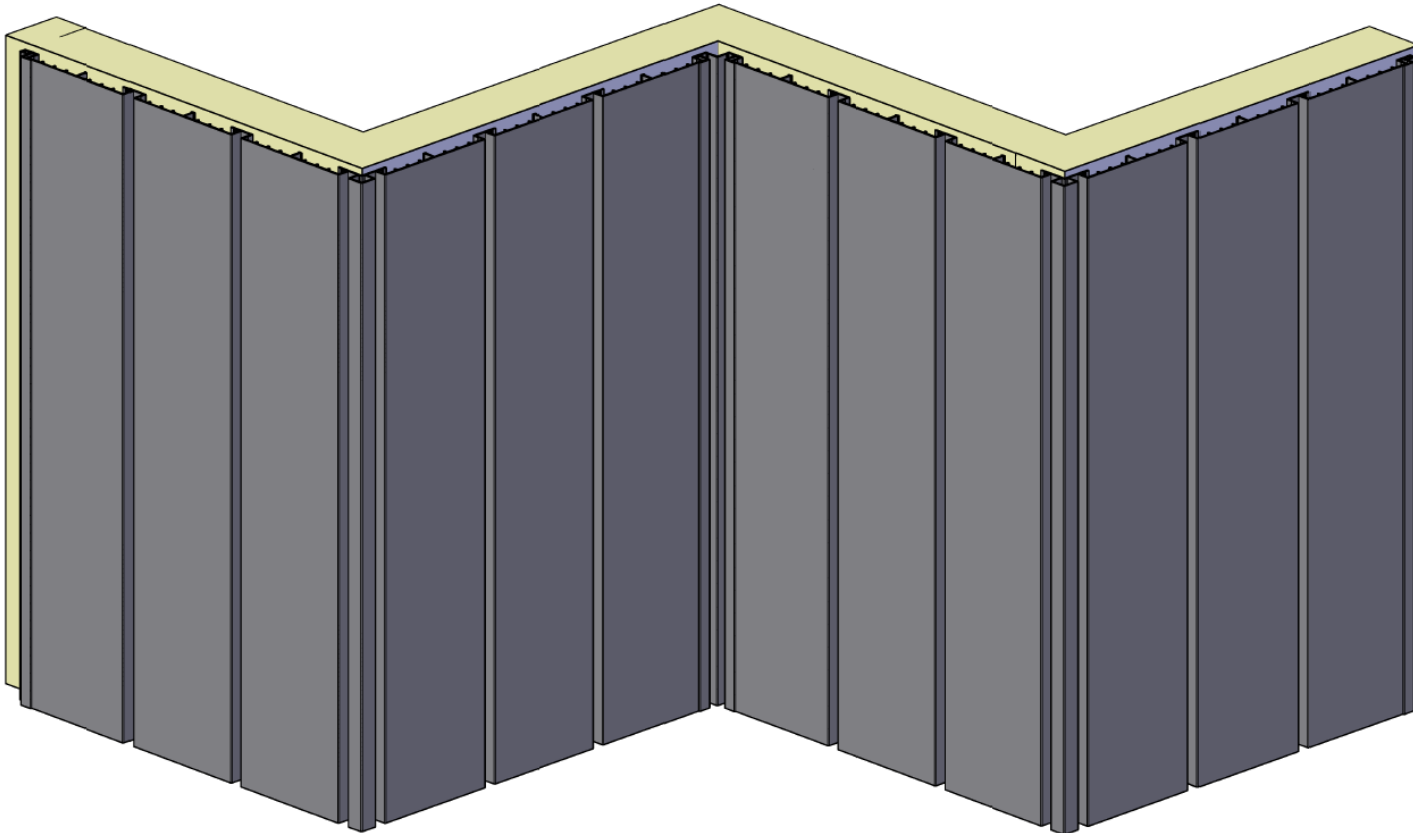

Combination of decorative profiles

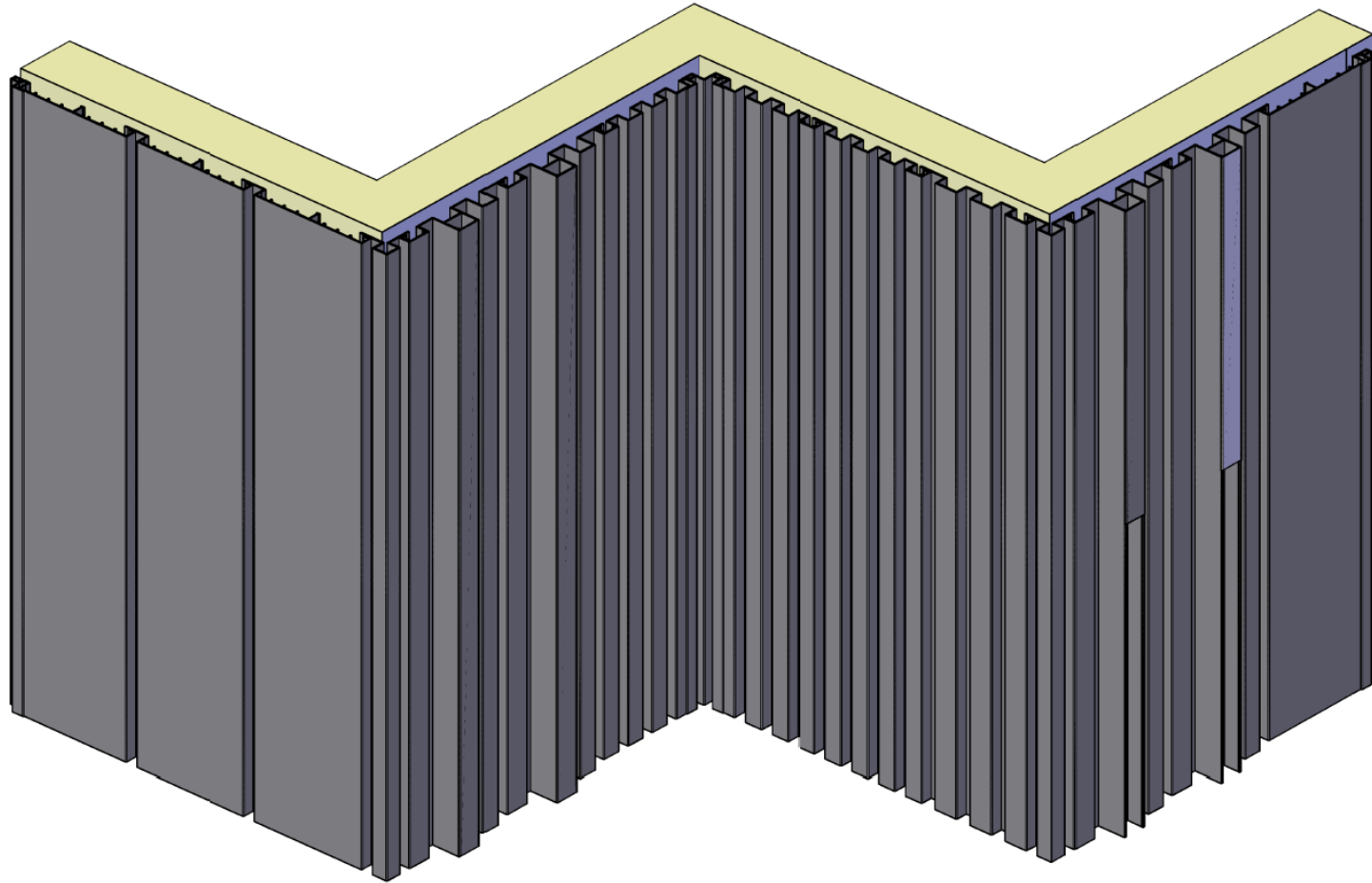

End profile 35.5x24mm

WD_3524

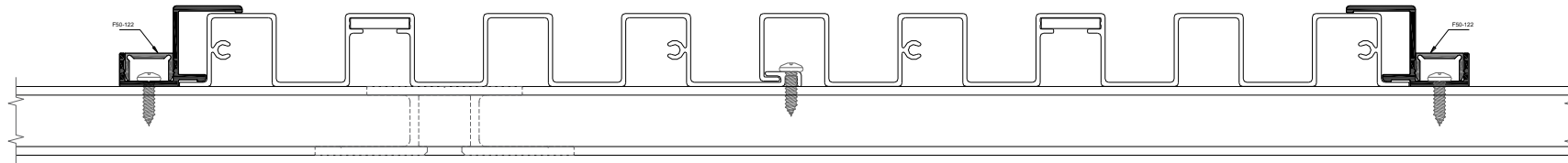
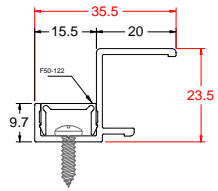

Profile thickness 1,5mm

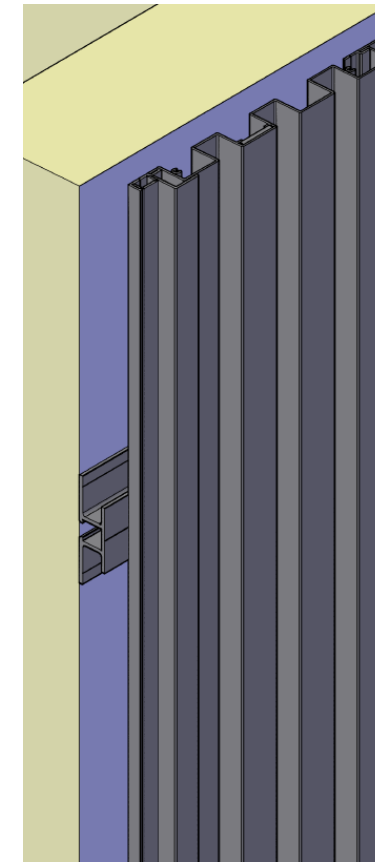
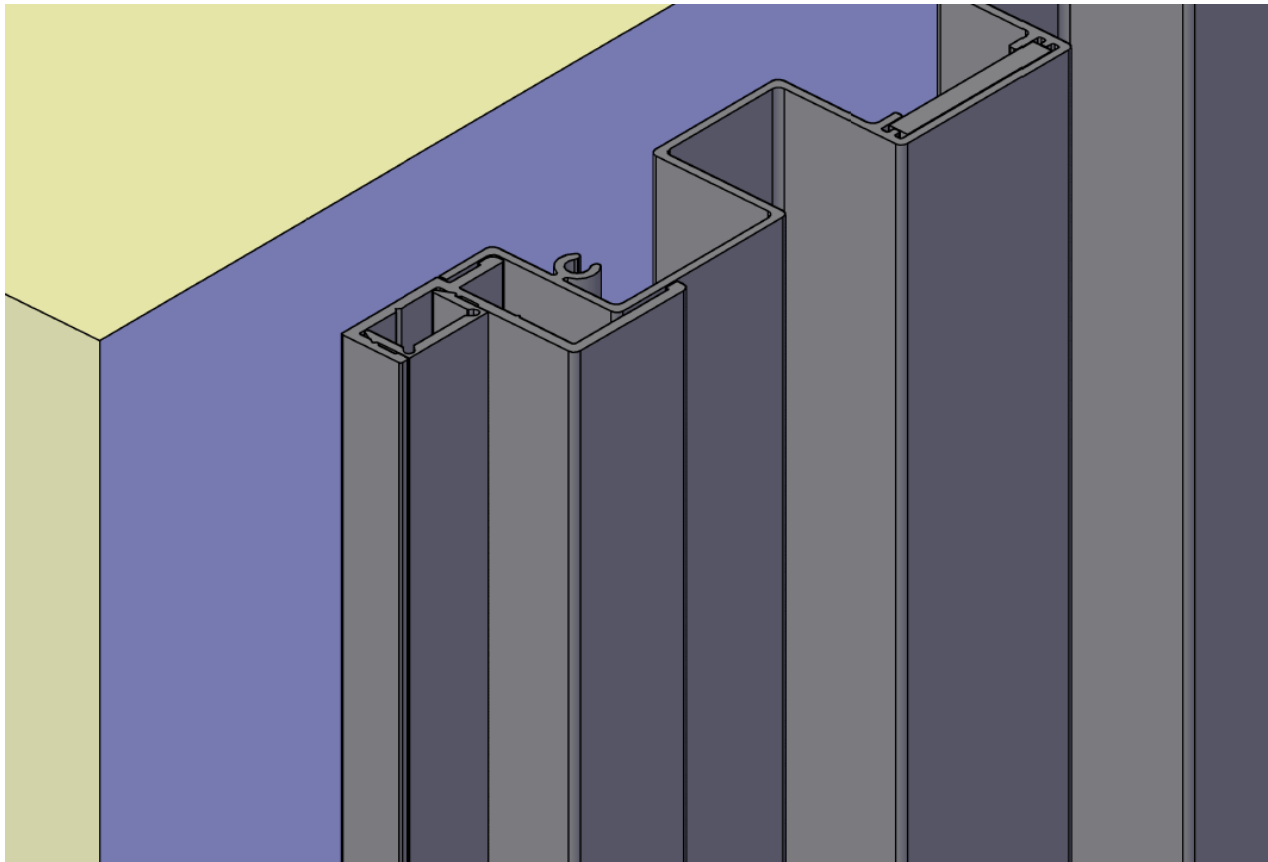

Rail track 75x20mm

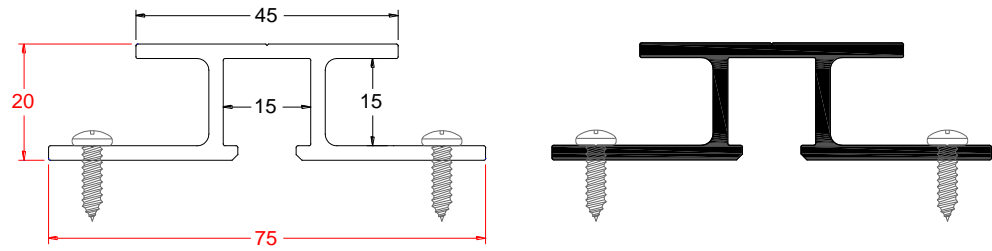

Profile thickness 2.5mm

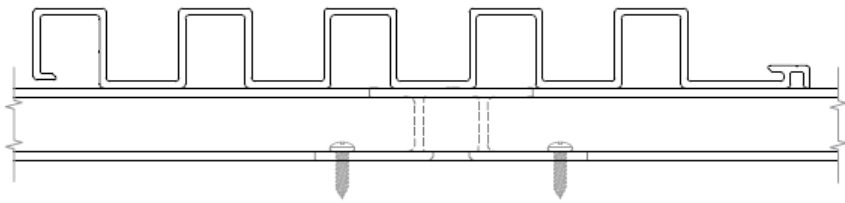

WD_7520

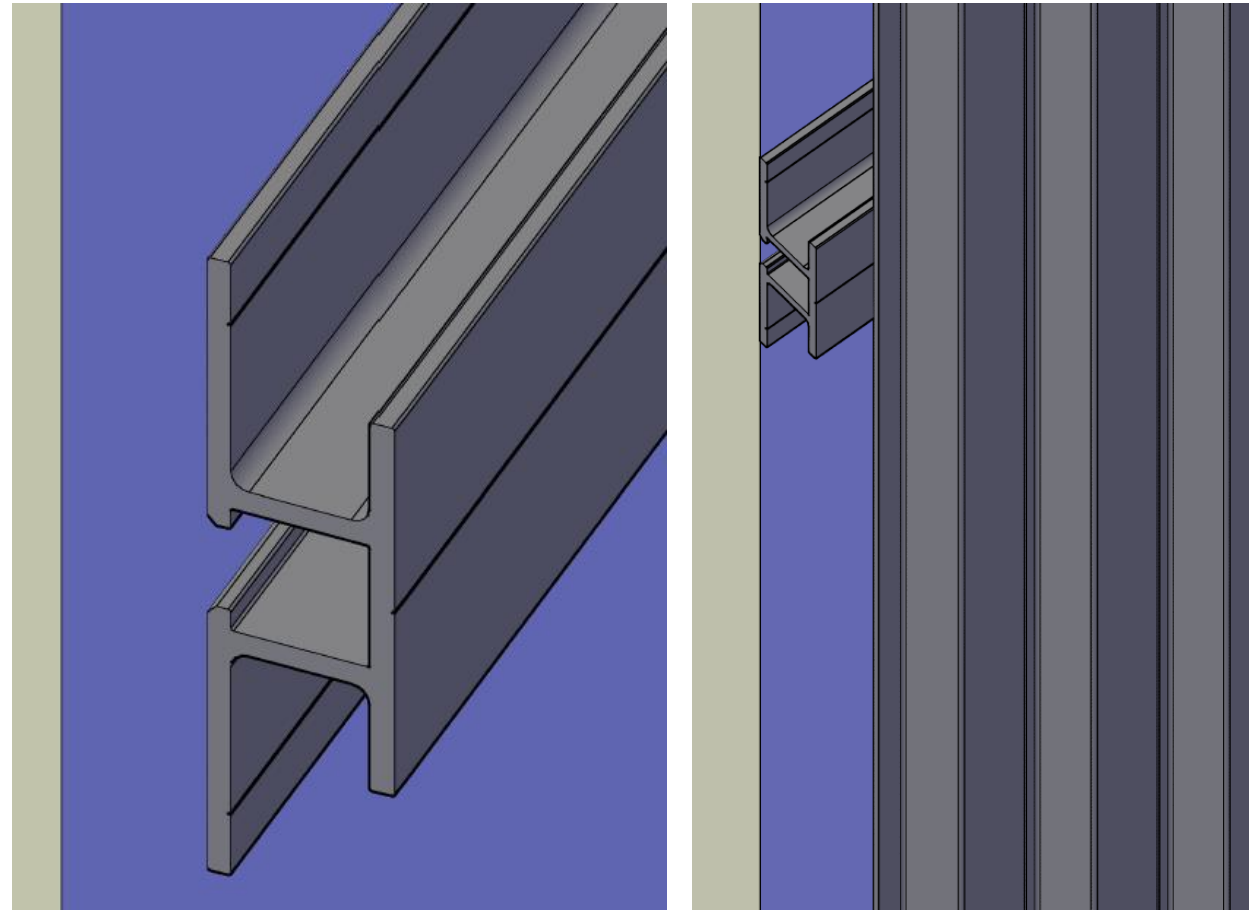

Aluminum cap / Plastic cap 40x4.7mm

WD_40

A240-002

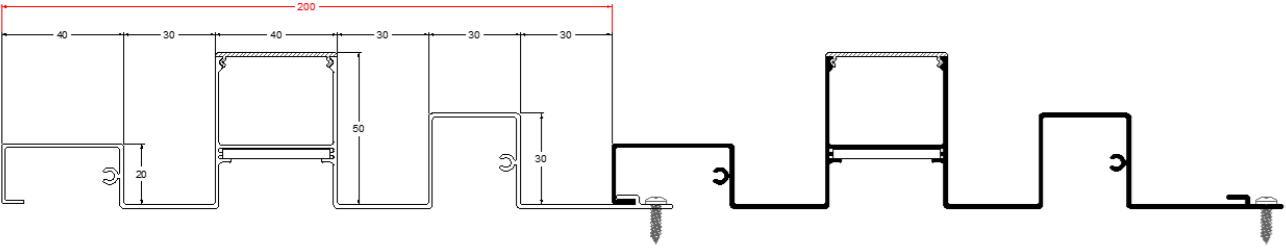

WD_40 Profile thickness 1.2mm

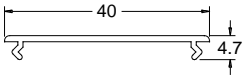

A240-002 Profile thickness 1.2mm

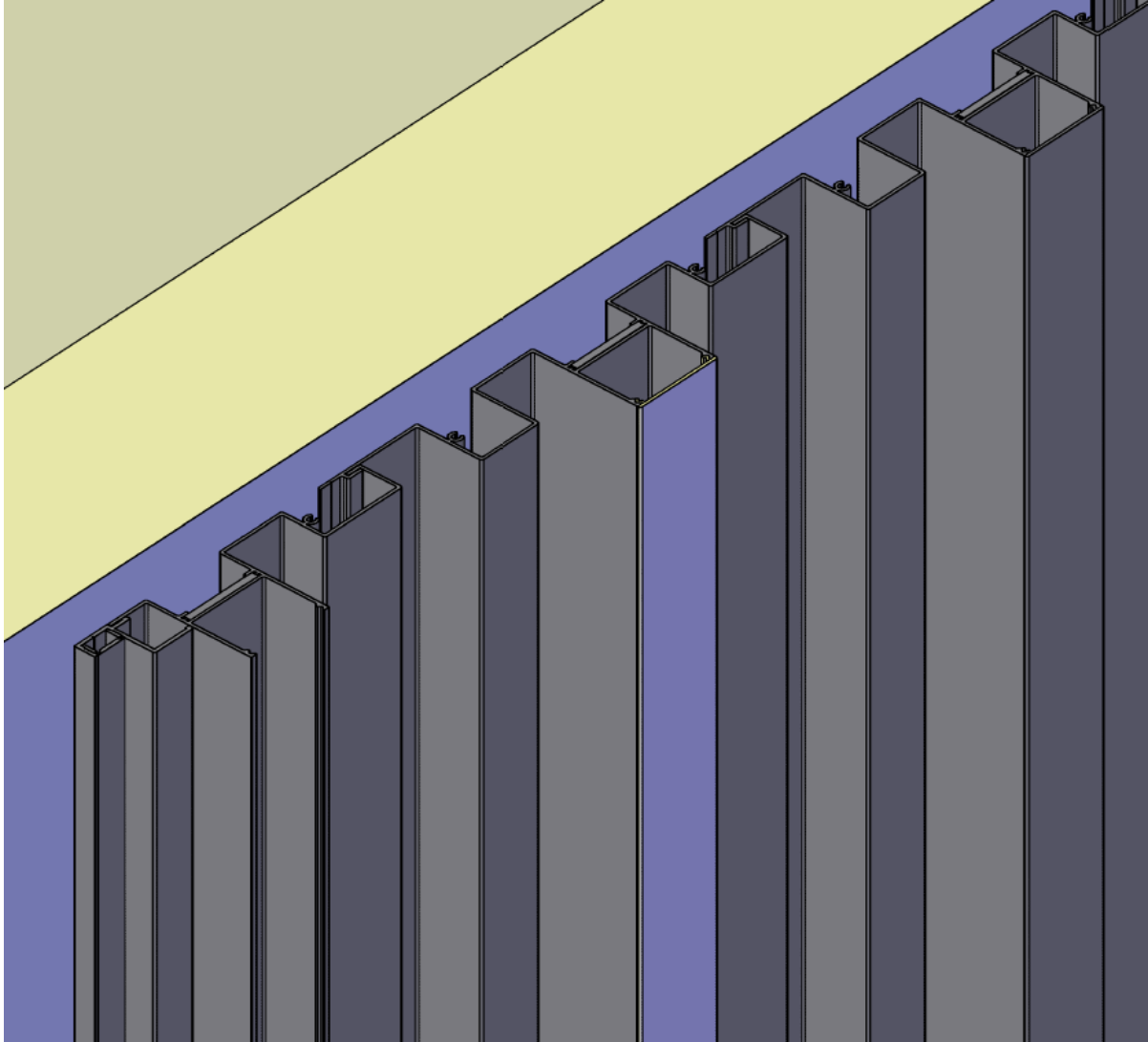
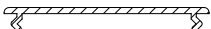
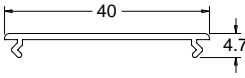

Inside Corner profile

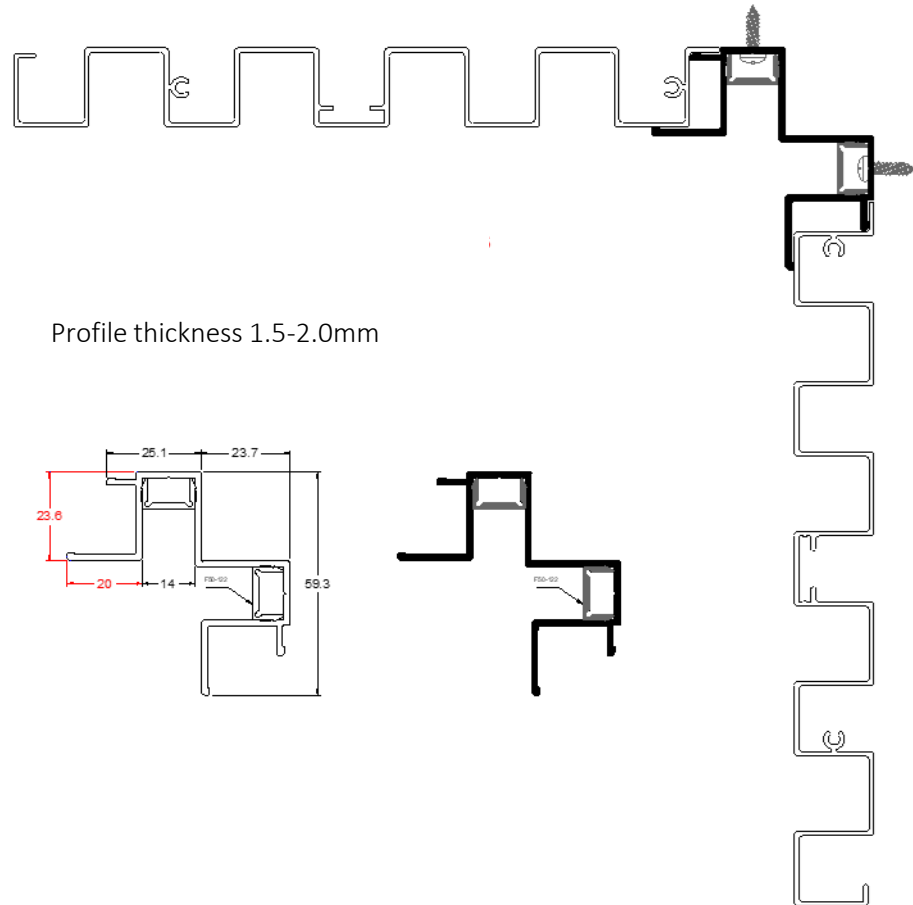

WD_2024

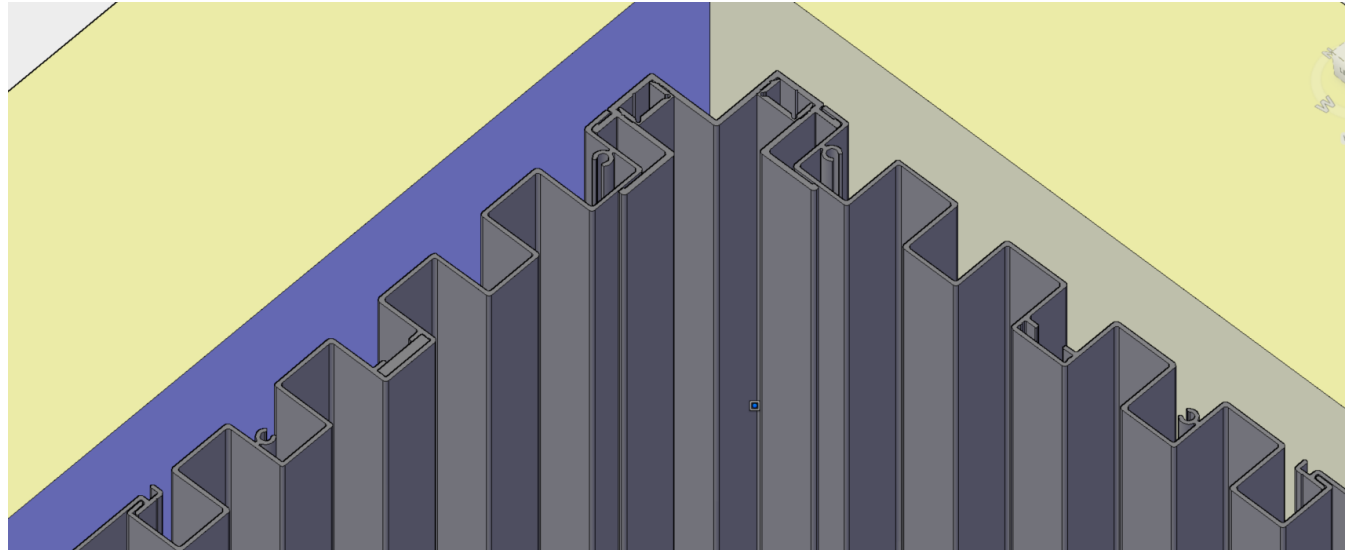

Outside Corner profile

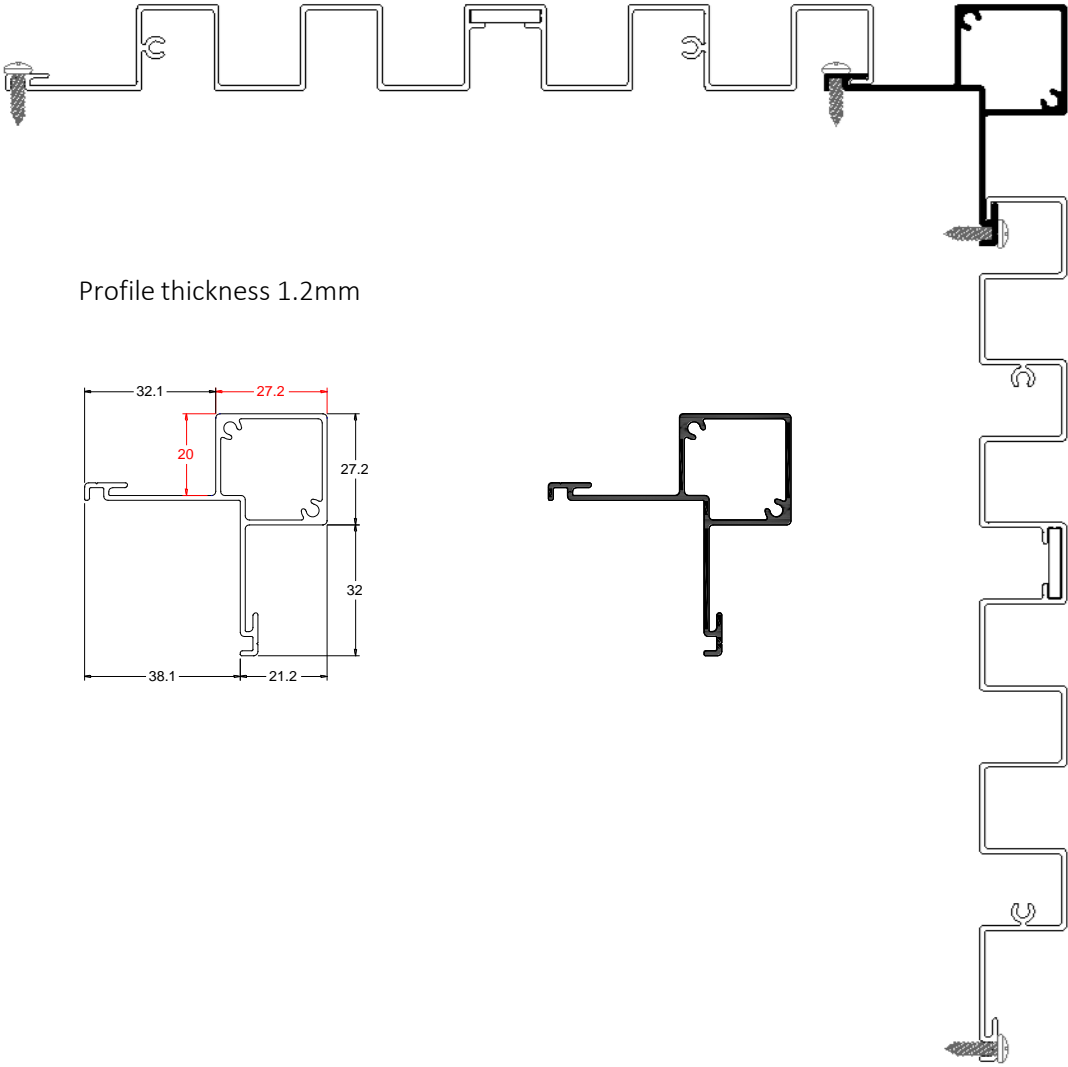

WD_201

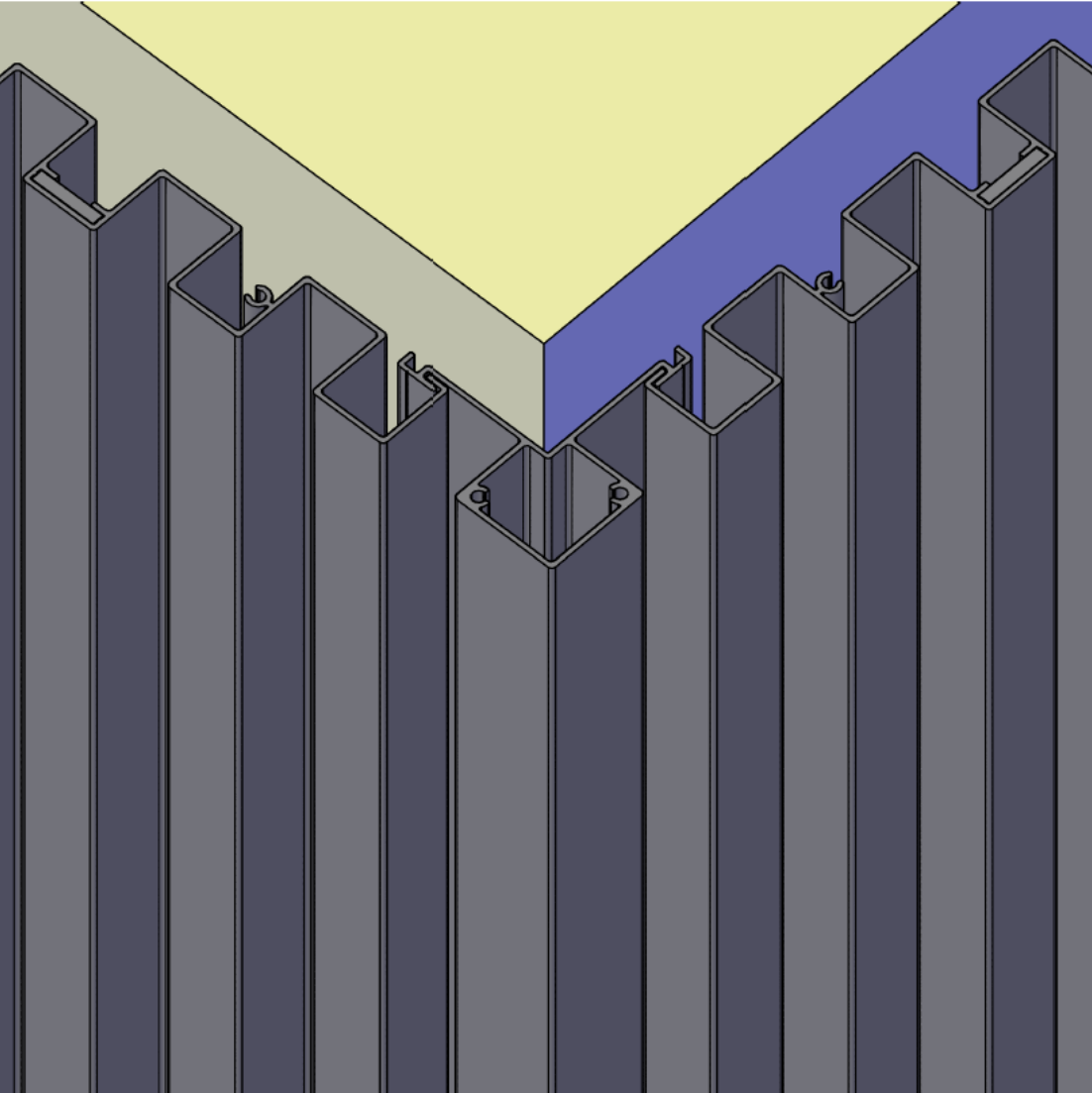

Outside Corner profile

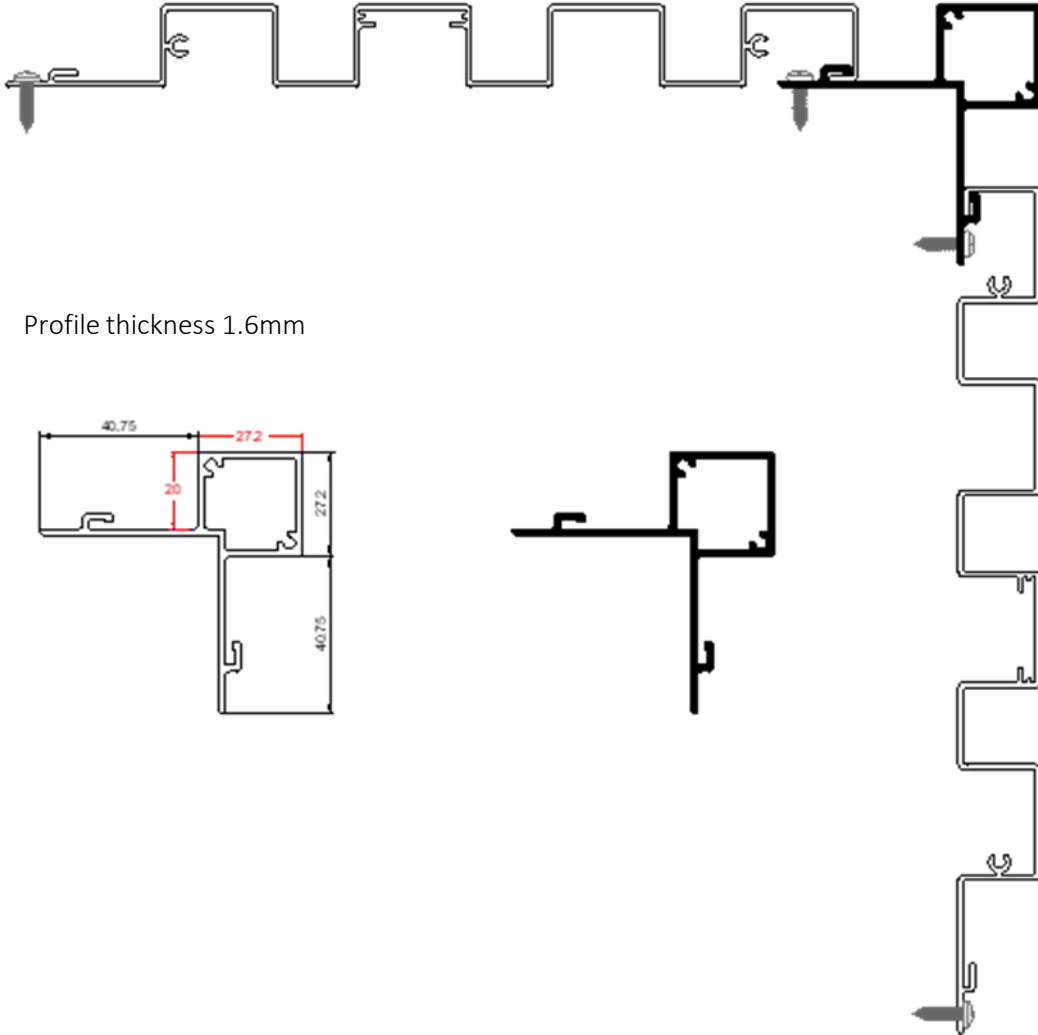

WD_202

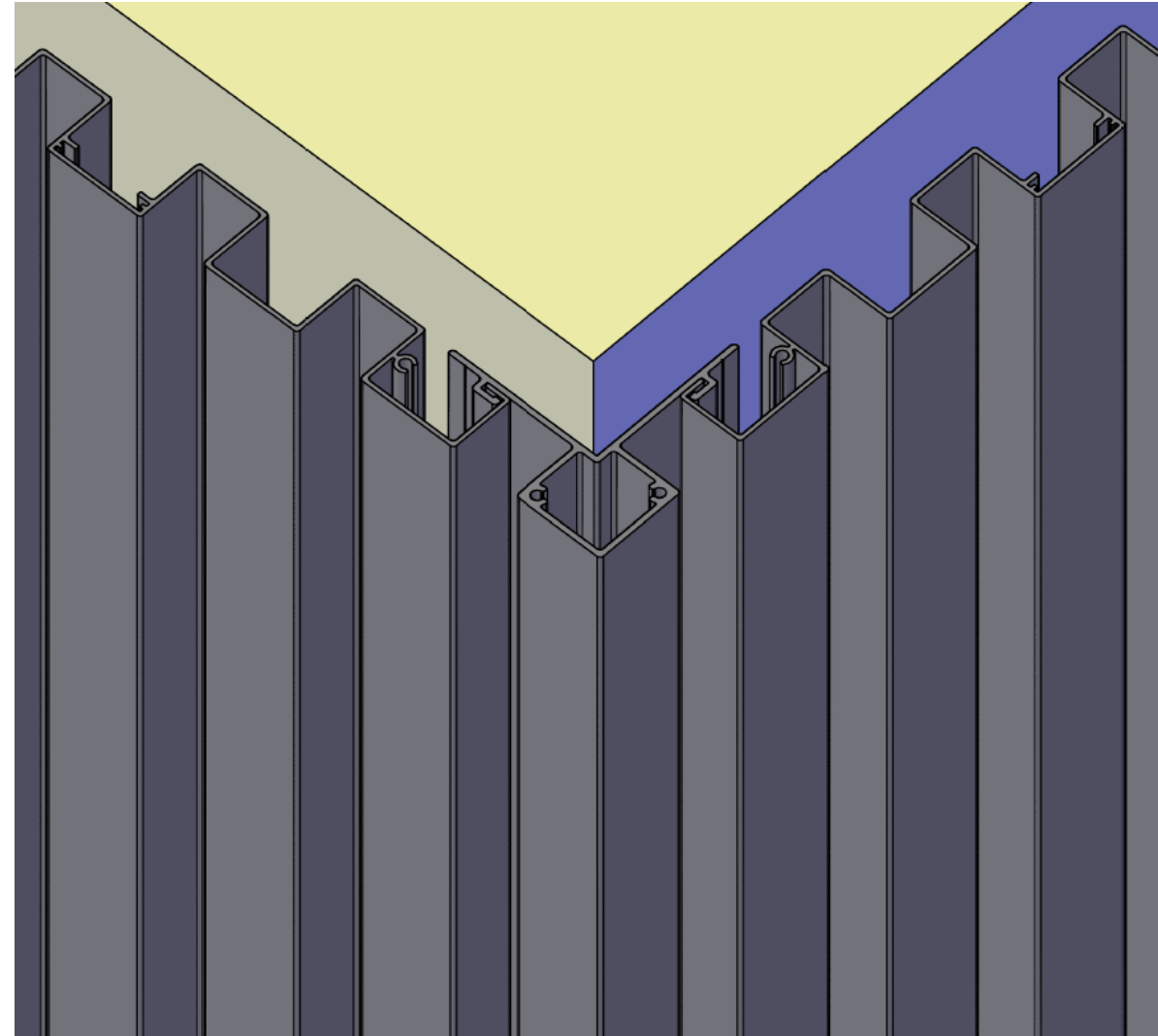

Additional profile WD-1918 for led lighting

WD_1918



Profile thickness 1.0-1.6mm

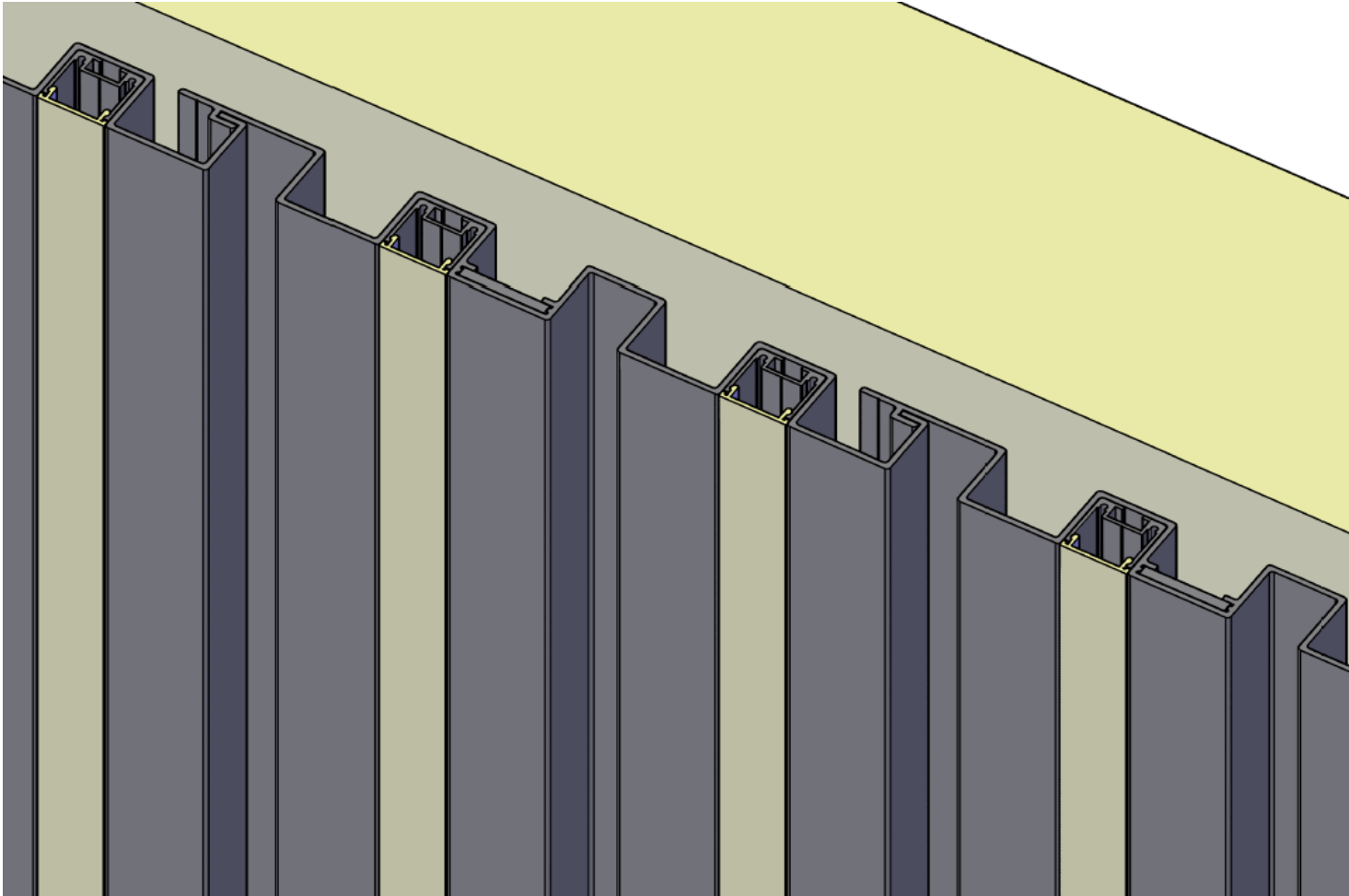
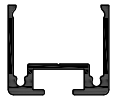
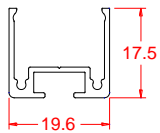

Outside Corner option with WD-3524

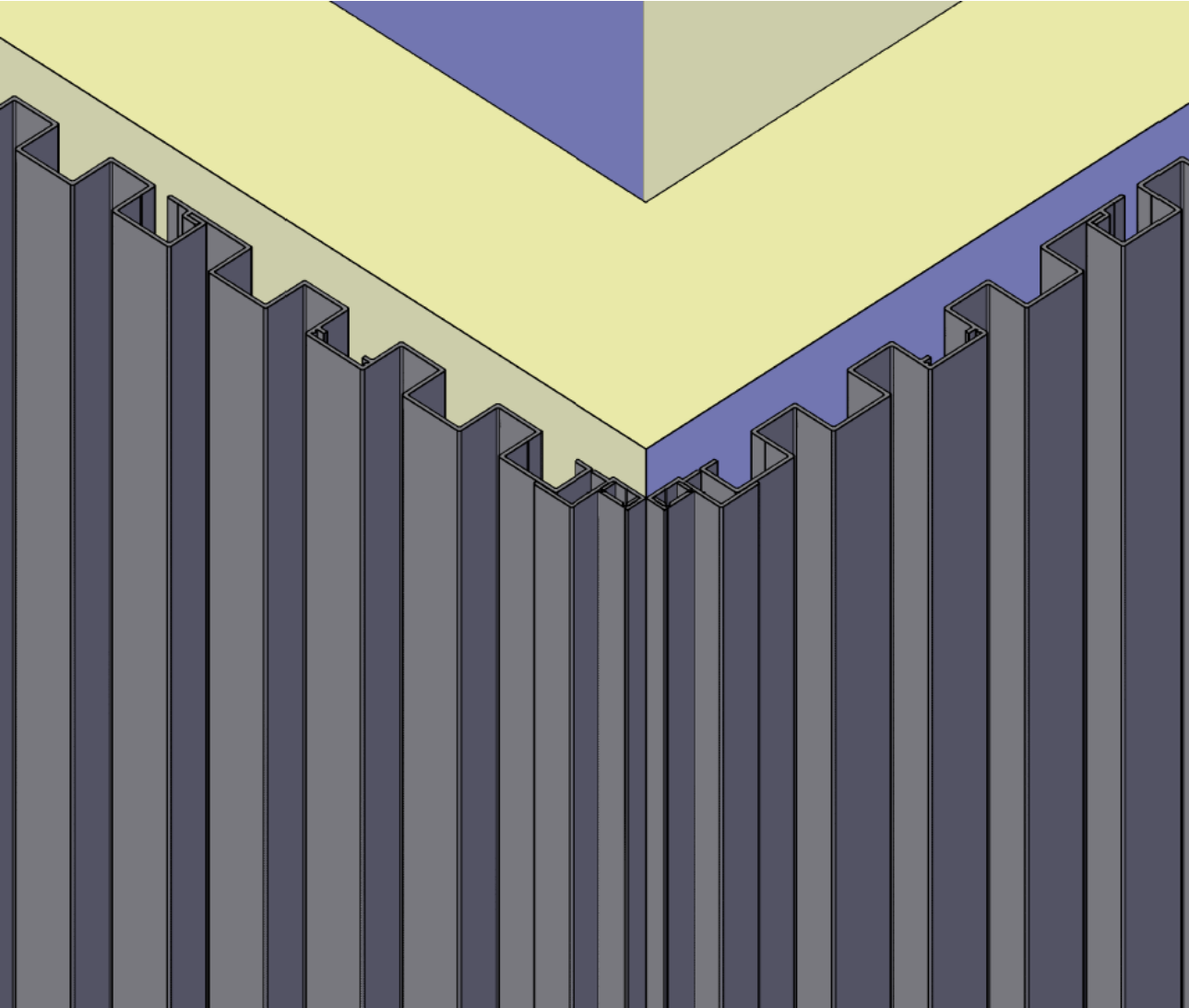



THANK YOU